

marantz®

Model SR9600 User Guide

AV Surround Receiver



CAUTION



**RISK OF ELECTRIC SHOCK
DO NOT OPEN**

**CAUTION: TO REDUCE THE RISK OF ELECTRIC SHOCK,
DO NOT REMOVE COVER (OR BACK)
NO USER-SERVICEABLE PARTS INSIDE
REFER SERVICING TO QUALIFIED SERVICE PERSONNEL**

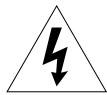

The lightning flash with arrowhead symbol within an equilateral triangle is intended to alert the user to the presence of uninsulated "dangerous voltage" within the product's enclosure that may be of sufficient magnitude to constitute a risk of electric shock to persons.



The exclamation point within an equilateral triangle is intended to alert the user to the presence of important operating and maintenance (servicing) instructions in the literature accompanying the product.

WARNING

**TO REDUCE THE RISK OF FIRE OR ELECTRIC SHOCK,
DO NOT EXPOSE THIS PRODUCT TO RAIN OR MOISTURE.**

**CAUTION: TO PREVENT ELECTRIC SHOCK, MATCH WIDE BLADE OF PLUG
TO WIDE SLOT, FULLY INSERT.**

**ATTENTION: POUR ÉVITER LES CHOC ÉLECTRIQUES, INTRODUIRE LA
LAME LA PLUS LARGE DE LA FICHE DANS LA BORNE CORRESPONDANTE
DE LA PRISE ET POUSSER JUSQU'AU FOND.**

NOTE TO CATV SYSTEM INSTALLER:

This reminder is provided to call the CATV (Cable-TV) system installer's attention to Section 820-40 of the NEC which provides guidelines for proper grounding and, in particular, specifies that the cable ground shall be connected to the grounding system of the building, as close to the point of cable entry as practical.

NOTE:

This equipment has been tested and found to comply with the limits for a Class B digital device, pursuant to Part 15 of the FCC Rules. These limits are designed to provide reasonable protection against harmful interference in a residential installation. This equipment generates, uses and can radiate radio frequency energy and, if not installed and used in accordance with the instructions, may cause harmful interference to radio communications. However, there is no guarantee that interference will not occur in a particular installation. If this equipment does cause harmful interference to radio or television reception, which can be determined by tuning the equipment off and on, the user is encouraged to try to correct the interference by one or more of the following measures:

- Reorient or relocate the receiving antenna.
- Increase the separation between the equipment and receiver.
- Connect the equipment into an outlet on a circuit different from that to which the receiver is connected.
- Consult the dealer or an experienced radio/TV technician for help.

NOTE:

Changes or modifications may cause this unit to fail to comply with Part 15 of the FCC Rules and may void the user's authority to operate the equipment.

This Class B digital apparatus complies with Canadian ICES-003.

Cet appareil numérique de la Classe B est conforme à la norme NMB-003 du Canada.

IMPORTANT SAFETY INSTRUCTIONS

READ BEFORE OPERATING EQUIPMENT

This product was designed and manufactured to meet strict quality and safety standards. There are, however, some installation and operation precautions which you should be particularly aware of.

1. Read these instructions.
2. Keep these instructions.
3. Heed all warnings.
4. Follow all instructions.
5. Do not use this apparatus near water.
6. Clean only with dry cloth.
7. Do not block any ventilation openings. Install in accordance with the manufacture's instructions.
8. Do not install near any heat sources such as radiators, heat registers, stoves, or other apparatus (including amplifiers) that produce heat.
9. Do not defeat the safety purpose of the polarized or grounding-type plug. A polarized plug has two blades with one wider than the other. A grounding type plug has two blades and a third grounding prong. The wide blade or the third prong are provided for your safety. If the provided plug does not fit into your outlet, consult an electrician for replacement of the obsolete outlet.
10. Protect the power cord from being walked on or pinched particularly at plugs, convenience receptacles, and the point where they exit from the apparatus.
11. Only use attachments/accessories specified by the manufacturer.
12. Use only with the cart, stand, tripod, bracket, or table specified by the manufacturer, or sold with the apparatus. When a cart is used, use caution when moving the cart/apparatus combination to avoid injury from tip-over.



13. Unplug this apparatus during lightning storms or when unused for long periods of time.
14. Refer all servicing to qualified service personnel. Servicing is required when the apparatus has been damaged in any way, such as power-supply cord or plug is damaged, liquid has been spilled or objects have fallen into the apparatus, the apparatus has been exposed to rain or moisture, does not operate normally, or has been dropped.

Additional Safety Information!

- This product should not be placed in a built-in installation such as a bookcase or rack unless proper ventilation is provided or the manufacturer's instructions have been adhered to.
- Apparatus shall not be exposed to dripping or splashing and that no objects filled with liquids, such as vases, shall be placed on the apparatus.
- When the switch is in the OFF position, the apparatus isn't completely switched-off from the MAINS.

TABLE OF CONTENTS

INTRODUCTION	1	BASIC OPERATION (PLAYBACK) ...	48
PRECAUTIONS	1	SELECTING AN INPUT SOURCE	48
DESCRIPTION	2	i.LINK FUNCTION	48
FEATURES	4	VIDEO CONVERT	48
ACCESSORIES	5	SELECTING THE SURROUND MODE	49
FRONT PANEL	6	ADJUSTING THE MAIN VOLUME	49
FL DISPLAY AND INDICATOR	7	ADJUSTING THE TONE (BASS & TREBLE) CONTROL	49
REAR PANEL	8	TEMPORARILY TURNING OFF THE SOUND	49
REMOTE CONTROLLER RC3200B .	10	USING THE SLEEP TIMER	49
NAMES AND FUNCTIONS	10	NIGHT MODE	50
LOADING BATTERIES	10	DIALOGUE NORMALIZATION MESSAGE	50
REMOTE-CONTROLLABLE RANGE	10	RE-EQ	50
ACTIVATING THE RC3200B	11	LIP.SYNC	50
OPERATING DEVICES	11	SURROUND MODE	51
A/V AMP	12	SURROUND	51
MULTI ROOM A/B	13	SOURCE DIRECT	51
TUNER 1/2	15	PURE DIRECT	51
RECORDING MACROS	15	OTHER FUNCTION	55
SHOW THE SR9600 STATUS ON THE RC3200B	16	VIDEO AUTO ON/OFF FUNCTION	55
WORKING WITH MODES	17	AUTO VIDEO SELECTOR (AUTO VIDEO SEL)	55
ADJUSTING THE SETTINGS	17	ATTENUATION TO ANALOG INPUT SIGNAL	55
LEARNING COMMANDS	19	LISTENING THROUGH HEADPHONES	55
RC3200B SETUP	20	DOLBY HEADPHONE MODE	55
IMPORTANT NOTICES	20	VIDEO ON/OFF	56
CLEANING RC3200B	20	DISPLAY MODE	56
HOW TO RESET THE RC3200B	20	SELECTING ANALOG AUDIO INPUT OR DIGITAL	
CONNECTIONS	21	AUDIO INPUT	56
SPEAKER PLACEMENT	21	RECORDING AN ANALOG SOURCE	56
CONNECTING SPEAKERS	21	7.1 CH INPUT	57
CONNECTING AUDIO COMPONENTS	22	SPEAKER A/B	57
CONNECTING VIDEO COMPONENTS	23	AUX2 INPUT	57
ADVANCED CONNECTION	25	BASIC OPERATION (TUNER)	58
CONNECTING THE REMOTE CONTROL JACKS	25	LISTENING TO THE TUNER	58
CONNECTING THE ANTENNA TERMINALS	26	PRESET MEMORY	59
CONNECTING FOR MULTIROOM LISTENING	27	MULTIROOM	
CONNECTING i.LINK COMPONENTS	28	SYSTEM	61
CONNECTING OTHER EQUIPMENT	29	MULTIROOM PLAYBACK USING THE MULTI ROOM	
SETUP	30	OUT TERMINALS	61
ONSCREEN DISPLAY MENU SYSTEM	30	MULTI ROOM PLAYBACK USING THE MULTI SPEAKER	
1 INPUT SETUP	32	TERMINALS	61
2 SPKR (SPEAKER) SETUP	35	OPERATION OF THE MULTIROOM OUTPUTS WITH THE	
3 SURROUND SETUP	41	REMOTE CONTROL FROM MULTI A OR B ROOM	62
4 VIDEO SETUP	43	TROUBLESHOOTING	63
5 PREFERENCE	44	HDMI	64
6 ACOUSTIC EQ	46	i.LINK (AUDIO)	64
7 AUDIO STATUS	47	TECHNICAL	
		SPECIFICATIONS	65
		DIMENSIONS	65

INTRODUCTION

Thank you for purchasing the Marantz SR9600 Surround Receiver.

This remarkable component has been engineered to provide you with many years of home theater enjoyment. Please take a few minutes to read this manual thoroughly before you connect and operate the SR9600.

As there are a number of connection and configuration options, you are encouraged to discuss your own particular home theater setup with your Marantz A/V specialist dealer.

PRECAUTIONS

DO NOT LOCATE IN THE FOLLOWING PLACES

To ensure long-lasting use, do not locate the SR9600 where it is:

- Exposed to direct sunlight.
- Near sources of heat such as heaters.
- In highly humid or poorly ventilated environments.
- Dusty.
- Subjected to mechanical vibrations.
- On wobbly, inclined or otherwise unstable surfaces.
- In locations such as in cramped audio racks where radiated heat is blocked. To ensure proper heat radiation, ensure the below clearance from walls and other equipment.

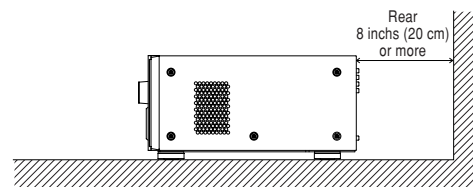
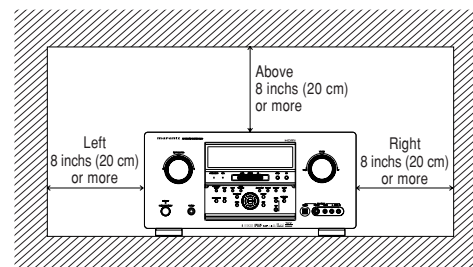

DESCRIPTION

THX

U L T R A.

THX® is an exclusive set of standards and technologies established by the world-renowned film production company, Lucasfilm Ltd. THX resulted from George Lucas' desire to reproduce the movie soundtrack as faithfully as possible both in the movie theater and in the home theater.

THX engineers developed patented technologies to accurately translate the sound from a movie theater environment into the home, correcting the tonal and spatial errors that occur.

When the THX mode of the SR9600 is on, three distinct THX technologies are automatically added:

Re-Equalization-restores the correct tonal balance for watching a movie in a home environment.

These sounds are otherwise mixed to be brighter for a large movie theater. Re-EQ compensates for this and prevents the soundtracks from being overly bright and harsh when played in a home theater.

Timbre Matching-filters the information going to the surround speakers so they more closely match the tonal characteristics of the sound coming from the front speakers.

This ensures seamless panning between the front and surround speakers.

Adaptive Decorrelation-slightly changes one surround channel's time and phase relationship with respect to the other surround channel.

This expands the listening position and creates with only two surround speakers the same spacious surround experience as in a movie theater with multiple surround speakers.

The Marantz SR9600 was required to pass a rigorous series of quality and performance tests, in addition to incorporating the technologies explained above, in order to be THX Ultra certified by Lucasfilm Ltd.

THX Ultra requirements cover every aspect of performance including pre-amplifier and power amplifier performance and operation, and hundreds of other parameters in both the digital and analog domain.

Movies which have been encoded in Dolby Digital, DTS, Dolby Pro Logic, stereo and Mono will all benefit from the THX mode when being viewed.

The THX mode should only be activated when watching movies which were originally produced for a movie theater environment.

THX need not be activated for music, movies made especially for TV, or shows such as sports programming, talk shows, etc. This is because they were originally mixed for a small room environment.

THX and Ultra 2 are trademarks or registered trademarks of THX Ltd. Surround EX is a jointly developed technology of THX and Dolby Laboratories, Inc. and is a trademark of Dolby Laboratories, Inc. Used under authorization. All rights reserved.

THX

U L T R A₂.

The **THX Ultra2** specification provides uncompromised 7.1 channel playback of any multi-channel program, whether movie soundtracks or music over the widest possible seating area. There are an additional two processing's for THX Ultra2 as bellow.

A.S.A. (Advanced Speaker Array)

"ASA" is a proprietary THX technology which processes the sound fed to 2 surround and 2 surround back speakers to provide the optimal surround sound experience. When you set up your home theater system using all eight speaker outputs (Left, Center, Right, Surround Right, Surround Back Right, Surround Back Left, Surround Left and Subwoofer), placing the two Surround Back speakers close together facing the front of the room as shown in the diagram will provide the largest sweet spot. If for practical reasons you have to place the Surround Back speakers apart, you will need to go to the **THX Audio Set-up** screen and choose the setting that most closely corresponds to the speaker distance, which will re-optimize the surround sound-field. ASA is used in two new surround modes; THX Ultra2 Cinema, THX Music Mode and THX Games mode.

B.G.C. (Boundary Gain Compensation)

If your chosen listening room layout (for practical or aesthetic reasons) results in most of the listeners being close to the rear wall, the resulting bass level can be sufficiently reinforced by the boundary that the overall sound quality becomes "boomy". THX Ultra2 receivers contain the BGC (Boundary Gain Compensation) feature to provide an improved bass balance. BGC can be selected by choosing "THX Ultra2 Subwoofer-Yes" from the "Boundary Gain Compensation" section of the "THX Audio setup menu".

THX SURROUND EX

THX Surround EX—Dolby Digital Surround EX is a joint development of Dolby Laboratories and THX Ltd.

In a movie theater, film soundtracks that have been encoded with Dolby Digital Surround EX technology are able to reproduce an extra channel which has been added during the mixing of the program. This channel, called Surround Back, places sounds behind the listener in addition to the currently available front left, front center, front right, surround right, surround left and subwoofer channels. This additional channel provides the opportunity for more detailed imaging behind the listener and brings more depth, spacious ambience and sound localization than ever before. Movies that were created using the Dolby Digital Surround EX technology, when released into the home consumer market may exhibit wording to that effect on the packaging. A list of movies created using this technology can be found on the Dolby web site at www.dolby.com. A list of available DVD software titles encoded with this technology can be found at www.thx.com.

Only receiver and controller products bearing the THX Surround EX logo, when in the THX Surround EX mode, faithfully reproduce this new technology in the home. This product may also engage the THX Surround EX mode during the playback of 5.1 channel material that is not Dolby Digital Surround EX encoded. In such case, the information delivered to the Surround Back channel will be program dependent and may or may not be very pleasing depending on the particular soundtrack and the tastes of the individual listener.

"SURROUND EX™" is a trademark of Dolby Laboratories. Used under authorization.

DIGITAL
dts
SURROUND

DTS was introduced in 1994 to provide 5.1 channels of discrete digital audio into home theater systems. DTS brings you premium quality discrete multichannel digital sound to both movies and music.

DTS is a multichannel sound system designed to create full range digital sound reproduction.

The no compromise DTS digital process sets the standard of quality for cinema sound by delivering an exact copy of the studio master recordings to neighborhood and home theaters.

Now, every moviegoer can hear the sound exactly as the moviemaker intended.

DTS can be enjoyed in the home for either movies or music on of DVD's, LD's, and CD's.

"DTS" and "DTS Digital Surround" are registered trademarks of Digital Theater Systems, Inc.

dts NEO:6

The advantages of discrete multichannel systems over matrix are well known.

But even in homes equipped for discrete multichannel, there remains a need for high-quality matrix decoding. This is because of the large library of matrix surround motion pictures available on disc and on VHS tape; and analog television broadcasts.

The typical matrix decoder of today derives a center channel and a mono surround channel from two-channel matrix stereo material. It is better than a simple matrix in that it includes steering logic to improve separation, but because of its mono, band-limited surround it can be disappointing to users accustomed to discrete multichannel.

Neo:6 offers several important improvements as follow,

- Neo:6 provides up to six full-band channels of matrix decoding from stereo matrix material. Users with 6.1 and 5.1 systems will derive six and five separate channels, respectively, corresponding to the standard home-theater speaker layouts.
- Neo:6 technology allows various sound elements within a channel or channels to be steered separately, and in a way which follows naturally from the original presentation.
- Neo:6 offers a music mode to expand stereo nonmatrix recordings into the five- or six-channel layout, in a way which does not diminish the subtlety and integrity of the original stereo recording.



DTS-ES Extended Surround is a new multichannel digital signal format developed by Digital Theater Systems Inc. While offering high compatibility with the conventional DTS Digital Surround format, DTS-ES Extended Surround greatly improves the 360-degree surround impression and space expression thanks to further expanded surround signals. This format has been used professionally in movie theaters since 1999.

In addition to the 5.1 surround channels (FL, FR, C, SL, SR and LFE), DTS-ES Extended Surround also offers the SB (Surround Back) channel for surround playback with a total of 6.1 channels. DTS-ES Extended Surround includes two signal formats with different surround signal recording methods, as DTS-ES Discrete 6.1 and DTS-ES Matrix 6.1.

“DTS”, “DTS-ES” and “Neo:6” are trademarks of Digital Theater Systems, Inc.



The stereo CD is a 16-bit medium with sampling at 44.1 kHz. Professional audio has been 20- or 24-bit for some time, and there is increasing interest in higher sampling rates both for recording and for delivery into the home. Greater bit depths provide extended dynamic range. Higher sampling rates allow wider frequency response and the use of anti-alias and reconstruction filters with more favorable aural characteristics.

DTS 96/24 allows for 5.1 channel sound tracks to be encoded at a rate of 96kHz/24bits on DVD-Video titles.

When DVD-video appeared, it became possible to deliver 24-bit, 96 kHz audio into the home, but only in two channels, and with serious limitations on picture. This capability has had little use. DVD-audio allows 96/24 in six channels, but a new player is needed, and only analog outputs are provided, necessitating the use of the D/A converters and analog electronics provided in the player.

DTS 96/24 offers the following:

1. Sound quality transparent to the original 96/24 master.
2. Full backward compatibility with all existing decoders. (Existing decoders will output a 48 kHz signal)
3. No new player required: DTS 96/24 can be carried on DVD-video, or in the video zone of DVD-audio, accessible to all DVD players.

4. 96/24 5.1-channel sound with full-quality full-motion video, for music programs and motion picture soundtracks on DVD-video.

“DTS” and “DTS 96/24” are trademarks of Digital Theater Systems, Inc.



Dolby Digital identifies the use of Dolby Digital audio coding for such consumer formats as DVD and DTV. As with film sound, Dolby Digital can provide up to five full-range channels for left, center, and right screen channels, independent left and right surround channels, and a sixth (“1”) channel for low-frequency effects.

Dolby Surround Pro Logic II is an improved matrix decoding technology that provides better spatiality and directionality on Dolby Surround program material; provides a convincing three-dimensional soundfield on conventional stereo music recordings; and is ideally suited to bring the surround experience to automotive sound. While conventional surround programming is fully compatible with Dolby Surround Pro Logic II decoders, soundtracks will be able to be encoded specifically to take full advantage of Pro Logic II playback, including separate left and right surround channels. (Such material is also compatible with conventional Pro Logic decoders.)

Dolby Digital EX creates six full-bandwidth output channels from 5.1-channel sources. This is done using a matrix decoder that derives three surround channels from the two in the original recording. For best results, Dolby Digital EX should be used with movies soundtracks recorded with Dolby Digital Surround EX.

About Dolby Pro Logic IIx

Dolby Pro Logic IIx technology delivers a natural and immersing 7.1-channel listening experience to the home theater environment. A product of Dolby's expertise in surround sound and matrix decoding technologies, Dolby Pro Logic IIx is a complete surround sound solution that maximizes the entertainment experience from stereo as well as 5.1-channel encoded sources.

Dolby Pro Logic IIx is fully compatible with Dolby Surround Pro Logic technology and can optimally decode the thousands of commercially available

Dolby Surround encoded video cassettes and television programs with enhanced depth and spatiality. It can also process any high-quality stereo or Advanced Resolution 5.1-channel music content into a seamless 6.1- or 7.1-channel listening experience.



The Dolby Headphone technology provides a surround sound listening experience over headphones. When listening to multichannel content such as DVD movies over headphones, the listening experience is fundamentally different than listening to speakers. Since the headphone speaker drivers are covering the pinna of the ear, the listening experience differs greatly from traditional speaker playback. Dolby utilizes patented headphone perspective curves to solve this problem and provides a non-fatiguing, immersive, home theater listening experience. Dolby Headphone also delivers exceptional 3D audio from stereo material.

Manufactured under license from Dolby Laboratories. “Dolby”, “Pro Logic”, and the double-D symbol are trademarks of Dolby Laboratories.



Circle Surround II (CS-II) is a powerful and versatile multichannel technology. CS-II is designed to enable up to 6.1 multichannel surround sound playback from mono, stereo, CS encoded sources and other matrix encoded sources. In all cases the decoder extends it into 6 channels of surround audio and a LFE/subwoofer signal. The CS-II decoder creates a listening environment that places the listener “inside” music performances and dramatically improves both hi-fi audio conventional surround-encoded video material. CS-II provides composite stereo rear channels to greatly improve separation and image positioning—adding a heightened sense of realism to both audio and A/V productions.

CS-II is packed with other useful feature like dialog clarity (SRS Dialog) for movies and cinema-like bass enrichment (TruBass). CS-II can enable the dialog to become clearer and more discernable in movies and it enables the bass frequencies contained in the original programming to more closely achieve low frequencies—overcoming the low frequency limitations of the speakers by full octave.

Circle Surround II, TruSurround XT, Dialog Clarity, TruBass, SRS, and  symbol are trademarks of SRS Labs, Inc.

Circle Surround II, TruSurround XT, Dialog Clarity and TruBass technologies are incorporated under license from SRS Labs, Inc.



HDCD[®] (High Definition Compatible Digital[®]) is a patented process for delivering on Compact Disc the full richness and details of the original microphone feed.

HDCD encoded CDs sound better because they are encoded with 20-bits of real musical information as compared to 16-bits for all other CDs.

HDCD overcomes the limitation of the 16-bit CD format by using a sophisticated system to encode the additional four bits onto the CD while remaining completely compatible with the CD format.

When listening to HDCD recordings, you hear more dynamic range, a focused 3-D sound stage, and extremely natural vocal and musical timbre. With HDCD, you get the body, depth and emotion of the original performance not a flat, digital imitation.

HDCD system manufactured under license from Microsoft. This product is covered by one or more of the following: In the United States 5,479,168 5,638,074 5,640,161 5,808,574 5,838,274 5,854,600 5,864,311 5,872,531 and in Australia 669,114 with other patents pending.

FEATURES

The SR9600 incorporates the latest generation of digital surround sound decoding technology such as Dolby Digital EX, Dolby Digital, DTS ES (Discrete 6.1 and Matrix 6.1), DTS Neo:6 (Cinema, Music), Dolby Pro-Logic II (Movie, Music and Game), Dolby Pro-Logic IIx (Movie, Music and Game), Circle Surround II (Cinema, Music and Mono).

In addition, Marantz has focused on the future. By utilizing pre-out jacks, 7.1 direct inputs and a RS-232C communication port, the SR9600 is tomorrow's technology, today!

• **THX Ultra certified**

7 ch amplifiers have enough power for even the most difficult conditions found in large rooms. Enormous power reserves endow the system with substantial dynamic ability at high sound levels. 140 watts to each of the seven main channels, the power amp section features an advanced, premium high- storage power supply capacitors, and fully discrete output stages housed in cast aluminum heat sinks .

• **Current feedback 7 ch amplifier**

Current feedback topology combines total operational stability with excellent frequency response, while requiring only minimal amounts of negative feedback. It offers excellent transient response and superb sonic transparency.

The SR9600 incorporates the most advanced Digital Signal Processing circuitry, along with a 192 kHz/24 bit D/A converter in each of the 7 channels. Independent power supply circuits are incorporated for the FL display, as well as audio and video sections for maximum separation, clarity and dynamic range. Together with hand-selected customized components, all elements work in harmony to recreate the emotion, exactly as the artist intended.

The SR9600 is designed and engineered with extensive feedback from custom installation experts, dealers and consumers. It features multi-room/multisource, assignable DC triggers, a RS-232C communication port, flasher input, IR receiver input, 4 emitter out heavy duty speaker binding posts and an extensive array of both analog and digital inputs/outputs. With 9 assignable digital inputs, 4 component video inputs, SACD multichannel (7.1 channel) direct inputs, video convert system and a speaker B and OSD output versatility is taken to a stunning new level. Furthermore, the SR9600 can output the OSD information through the Y/C (S-video) and composite video outputs.

An easy-to-use, programmable, learning remote control allows full access to all of the operating functions and can be used for system operation as well.

The new generation of Marantz Receivers is stylish and completely symmetrical. On the front panel of the SR9600, buttons are kept to a minimum. Source selectors and volume controls are intuitively placed. The SR9600 is here to perform in your unrivaled home entertainment setup.

• **i.LINK Transmission Formats**

i.LINK is the generic name for the IEEE 1394 digital interface standard of the Institute of Electrical and Electronics Engineers. It covers the transmission of data such as digital sound and the operation of connected devices.

Two i.Link transmission formats are MPEG-2TS, which is used in digital broadcasting, and DV, which is used by DVD recorders and for digital video.

This receiver supports the i.LINK (Audio)format. Only components that support i.LINK (Audio) can be connected to the SR9600. i.LINK (Audio) makes it possible to digitally transmit multichannel audio from DVD-Audio and Super Audio CDs.

This receiver also supports flow rate control. Using a high-precision crystal oscillator, this receiver can convert digital signals into analog signals without them being affected by jitter.

(i.LINK and the i.LINK logo  are trademarks of Sony Corp.)

Copyright Protection

This receiver supports DTCP (Digital Transmission Content Protection). DTCP protects copyrights by authenticating and encoding data transmissions between digital components that use i.LINK. To play back DVD-Audio or Super Audio CDs using i.LINK, the connected device must support DTCP. Before connecting a component to this receiver, refer to its instruction manual.

• **HDMI**

HDMI (High-Definition Multimedia Interface) is an enhancement to the DVI (Digital Visual Interface) standard. It adds capabilities for digitally transmitting audio signals in addition to video signals. Where multiple cables were previously needed for audio/video, HDMI enables audio/video connection via a single cable.

The HDMI jacks of this receiver support HDMI Ver. 1.1. The multichannel signals of DVD-Audio can be transmitted as digital signals without conversion.

Copyright Protection

This receiver supports HDCP (High-bandwidth Digital Content Protection). HDCP is copyright protection technology that consists of data encoding and other device authentication. Its purpose is to protect digital video content. Both this receiver and the connected component (such as a video player or monitor) must support HDCP. Before connecting a component to this receiver, refer to its instruction manual.

- THX/THX Surround EX
- Dolby Digital EX, Dolby Digital, DTS ES (Discrete 6.1, Matrix 6.1, Neo:6)
- Dolby Headphone
- Dolby Pro Logic IIx (Movie, Music, Game)
- Circle Surround II (Cinema, Music, Mono)
- HDCD decoding
- Bi-amp drive
- HDAM-SA2
- Source/Pure Direct mode
- 9 bands x 7 ch GEQ
- 8 ch level meter
- DSD direct conversion
- DSD to PCM converter
- MRAC (Marantz Room Acoustic Calibration)
- Improved station name input method, 50 presets
- Auto adjust function for speaker distance settings (delay time)
- Assignable 2 HDMI inputs
- Assignable 2 i.LINK inputs
- Lip sync. control
- 2 Multiroom operation
- Dual AM/FM Tuner
- 7 x 140 Watts (8 Ohms), discrete amplifiers
- High power current feedback circuitry
- Massive energy power supply, huge toroidal core transformer, large ELCO's
- 192 kHz/24 bit DAC for all 8 channels
- 32 bit digital surround processing chipsets
- Large heavy duty speaker terminals for all channels
- Auto input signal detection
- Front optical AUX input (digital camera, portable DVD)
- Main electric volume with zero-cross detection and 0.5dB per step control
- Multiroom speaker
- Video off mode
- Setup menu via all video output (composite, S-video and component video)
- Video conversion system (composite video ↔ S-video → component video)
- Auto video selector
- Video auto power on/off
- Two monitor outputs
- RS-232C terminal for future upgrade or system control
- Assignable 4 DC trigger outputs
- 4 emitter outputs
- Learning remote control
- Flasher input, IR receiver input
- Graphic display, 256 x 64 pixel
- Transmit/receive remote control system
- Copper plate chassis

ACCESSORIES

Remote control unit RC3200B

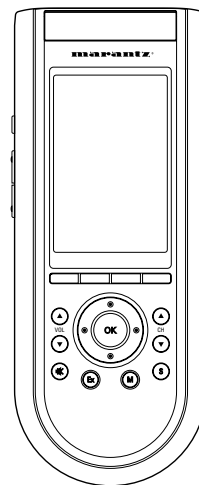

Microphone MC-10

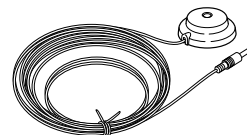

AC cable

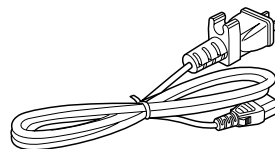

AA-size batteries x 3

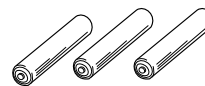

AM loop antenna x 2

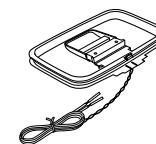

FM feeder antenna x 2

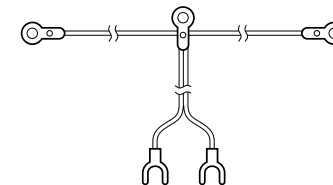

FM antenna adapter x 2

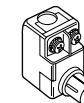

RS232C cable

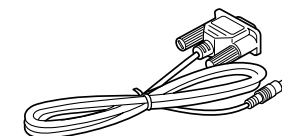

Front AUX jack cover

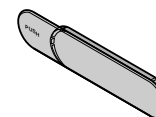

User guide

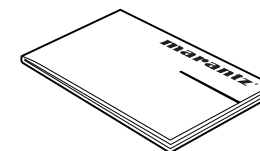

FRONT PANEL

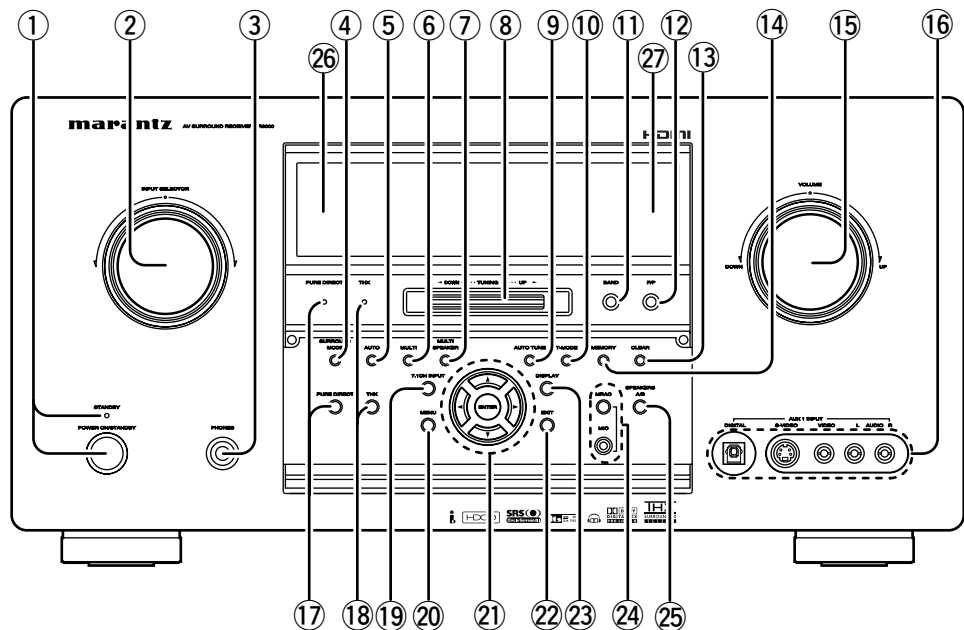

① **POWER switch and STANDBY indicator**

When this switch is pressed once, the unit turns ON and the display is illuminated. When pressed again, the unit turns OFF and the STANDBY indicator is illuminated.

② **INPUT SELECTOR knob (AUDIO/VIDEO)**

This knob is used to select the input source. Video selectors, such as DVD, LD, TV, DSS, VCR1, VCR2 and AUX1 select video and audio simultaneously. Audio function sources, such as TAPE, CD-R, CD, TUNER-1, TUNER-2 and AUX2 may be selected in conjunction with the video source.

This feature (Sound Injection) combines sound from one source with a picture from another. Choose the video source first, then choose a different audio source to activate this function.

③ **HEADPHONE jack for stereo headphones**

This jack may be used to listen to the SR9600's output through a pair of headphones. Be certain that the headphones have a standard 1/4" stereo phono plug. Note that the main room speakers will automatically be turned off when the headphone jack is in use.

Notes:

- When using headphones, the surround mode can be changed to STEREO or Dolby Headphone using **MENU** and **Cursor** button.
- The surround mode returns to the previous setting as soon as the headphone plug is removed from the jack.

④ **SURROUND MODE button**

You can select the surround mode by pressing this button. (See page 49)

⑤ **AUTO (Auto Surround) button**

Press this button to select the AUTO Surround mode. When this mode is selected, the receiver determines the surround mode corresponding to a digital input signal automatically. (See page 49)

⑥ **MULTI (Multiroom) button**

Press this button to activate the Multiroom system. "ROOM A/ROOM B" indicator will be illuminated in the display. (See page 61)

⑦ **MULTI SPEAKER button**

Press this button to activate the Multiroom Speaker system. "M-SP A/M-SP B" indicator will be illuminated in the display. (See page 61)

⑧ **GYRO TUNING dial**

Rotate this dial to change the frequency or the preset number of the tuner.

⑨ **AUTO TUNE button**

When this button is pressed and the GYRO TUNING dial is rotated, auto scan function of the tuner frequency starts.

⑩ **T-MODE (Tuner Mode) button**

Press this button to select the auto stereo mode or mono mode when the FM band is selected. The "AUTO" indicator lights in the auto stereo mode. (See page 58)

⑪ **BAND button**

Press this button to switch between FM and AM in the tuner mode.

⑫ **F/P (Frequency/Preset) button**

During reception of AM or FM, you can change the function of the GYRO TUNING dial for scanning frequencies or selecting preset stations by pressing this button.

⑬ **CLEAR button**

Press this button to cancel the station-memory setting mode or preset scan tuning. (See page 59)

⑭ **MEMORY button**

Press this button to enter the tuner preset memory numbers or station names. (See page 59)

⑮ **VOLUME control knob**

Adjusts the overall sound level. Turning the control clockwise increases the sound level.

⑯ **AUX1 INPUT jacks**

These auxiliary audio/video input jacks accept the connections of a camcorder, portable DVD, video game system, etc. When not using these jacks, protect with the included jack covers.

How to Attach the Front AUX Jack Cover

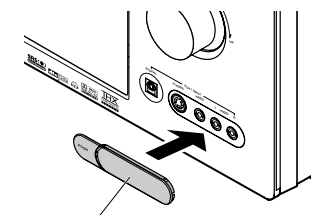

Front AUX Jack Cover

⑰ **PURE DIRECT button and indicator**

When this button is pressed once, "SOURCE DIRECT" appears on the FL display. If pressed again, "PURE DIRECT" appears. After 2 seconds, the FL display indication goes out. In the source/pure direct mode, the tone control circuitry and bass management are bypassed.

Notes:

- The surround mode is automatically switched to AUTO when the pure direct function is turned on.
- Additionally, speaker configurations are fixed automatically as follows.
Front SPKR = LARGE
Center SPKR = LARGE
Surround SPKR = LARGE
Surround Back SPKR = LARGE
Sub woofer = YES

⑱ **THX button and indicator**

Press this button to activate THX processing for the input source. The "THX" indicator is illuminated in the THX mode.

⑲ **7.1CH INPUT button**

Press this button to select the output of an external multichannel player.

⑳ **MENU button**

Press this button to enter the OSD menu system.

㉑ **Cursor (◀, ▶, ▲, ▼)/ENTER button**

Press these buttons when operating the OSD menu system and tuner function.

㉒ **EXIT button**

Press this button to exit from the OSD menu system.

23 DISPLAY button

When this button is pressed, the FL display mode is changed as follows :

Normal display → Level meter → Auto display off → Display off → Normal display.

The display off indicator "DISP" is illuminated when Display off is selected.

24 MRAC button/MIC jack

Press this button to automatically measure speaker characteristics using the included microphone (MC-10). (See page 36)

25 SPEAKER A/B button

Press this button to select speaker system A and/or B.

26 INFRARED receiver window

This window receives infrared signals for the remote control unit.

27 INFRARED transmitter window

This window transmits infrared signals for the remote control unit.

Opening and closing the front panel door

When you want to use the controls behind the front panel door, open the door by gently pressing on the lower part of the panel. Keep the door closed when not using these controls.

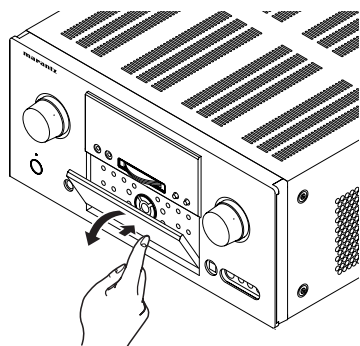

Caution:

- Be careful not to pinch your fingers between the door and the panel.

FL DISPLAY AND INDICATOR

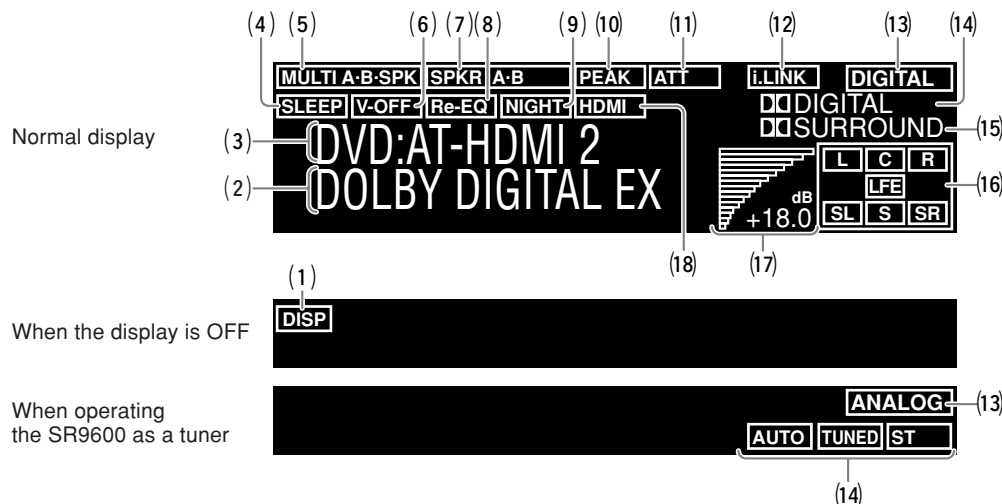

(1) DISP (Display Off) indicator

This indicator is illuminated when the SR9600 display is turned off.

(2) SURROUND mode / i.LINK indicator

This indicator is illuminated to show that the surround mode is in use. It also displays i.LINK information. (See page 28)

(3) Main Information Display

This display shows messages relating to the status, input source, tuner, audio input mode or other aspects of unit's operation.

(4) SLEEP timer indicator

This indicator is illuminated when the sleep timer function in the main room is in use.

(5) Multiroom system indicator

This indicator is illuminated when the multiroom system is active.

(6) V (Video)-OFF mode indicator

This indicator is illuminated when the Video off mode is selected.

(7) SPKR (Speaker) A/B indicator

This indicator displays which speaker system is active.

(8) Re-EQ indicator

This indicator is illuminated in the Re-EQ mode.

(9) NIGHT mode indicator

This indicator is illuminated when the SR9600 is in the Night mode, which reduces the dynamic range of digital program material at low volume levels.

(10) PEAK indicator

This indicator is a monitor for an analog audio input signal. If the selected analog audio input signal is greater than what the internal processor can hold, this is illuminated. If this happens, you should press the ATT button on the remote control unit. (See page 12)

(11) ATT (Attenuation) indicator

This indicator is illuminated when the attenuation function is active.

(12) HDMI/i.LINK indicator

HDMI
This indicator is illuminated when the audio signal input from the HDMI jacks is being played back.

i.LINK
This indicator is illuminated when the audio signal input from the i.LINK connector is being played back.

Note:

- This indicator flashes if the input signal cannot be detected.

(13) DIGITAL/ANALOG input indicator

DIGITAL
This indicator is illuminated when a digital input has been selected.

ANALOG
This indicator is illuminated when an analog input source has been selected.

(14) SIGNAL FORMAT and TUNER indicators

DIGITAL
This indicator is illuminated when a Dolby Digital signal is input.

EX
This indicator is illuminated when a Dolby Digital EX signal is input.

dts
This indicator is illuminated when a DTS signal is input.

ES
This indicator is illuminated when a DTS ES signal is input.

96/24
This indicator is illuminated when a DTS 96/24 signal is input.

PCM
This indicator is illuminated when the input signal is PCM (pulse code modulation).

HDCD
This indicator is illuminated when the input signal is from a HDCD.

Sampling frequency
This indicator displays the sampling frequency when a PCM or multi channel PCM signal is input. 32, 44.1 and 48 kHz are not displayed.

SA-CD
This indicator is illuminated when the input signal is from a SACD.

M-PCM
This indicator is illuminated when the input signal is multi channel PCM.

AUTO
This indicator is illuminated when the tuner's auto mode is in use.

TUNED
This indicator is illuminated when a station is being received with sufficient signal strength to provide acceptable listening quality.

ST (Stereo)
This indicator is illuminated when an FM station is being received in stereo.

(15) SIGNAL FORMAT indicators

■ SURROUND

This indicator is illuminated when a Dolby Surround signal is input.

MATRIX

This indicator is illuminated when a Matrix 6.1 Surround signal is input.

DISCRETE

This indicator is illuminated when a Discrete ES + Discrete 6.1 Surround signal is input.

DUAL MONO

This indicator is illuminated when a Dolby Digital or DTS dual mono signal is input.

NO AUDIO

This indicator is illuminated when the input signal is PCM NO AUDIO.

(16) ENCODED CHANNEL STATUS indicators

These indicators display the channels that are encoded with a digital input signal.

If the selected digital input signal is Dolby Digital 5.1 ch or DTS 5.1 ch, "L", "C", "R", "SL", "SR" and "LFE" will be illuminated.

If the digital input signal is 2 channel PCM-audio, "L" and "R" will be displayed. If Dolby Digital 5.1 ch signal with a Surround EX flag or DTS-ES signal comes in, "L", "C", "R", "SL", "S", "SR" and "LFE" will be illuminated.

When playing back a disk such as an SA-CD or DVD-Audio disk, the actual audio and display may not match with some DVD players.

(17) VOLUME indicator

The volume level is indicated as a bar graph and numerically in decibels.

(18) HDMI / HDMI THR indicator

HDMI

This indicator is illuminated when HDMI AUDIO is set to "ENABLE" and an HDMI device is connected to the SR9600.

HDMI THR

This indicator is illuminated when HDMI AUDIO is set to "THROUGH" and an HDMI device is connected to the SR9600. (See page 44)

REAR PANEL

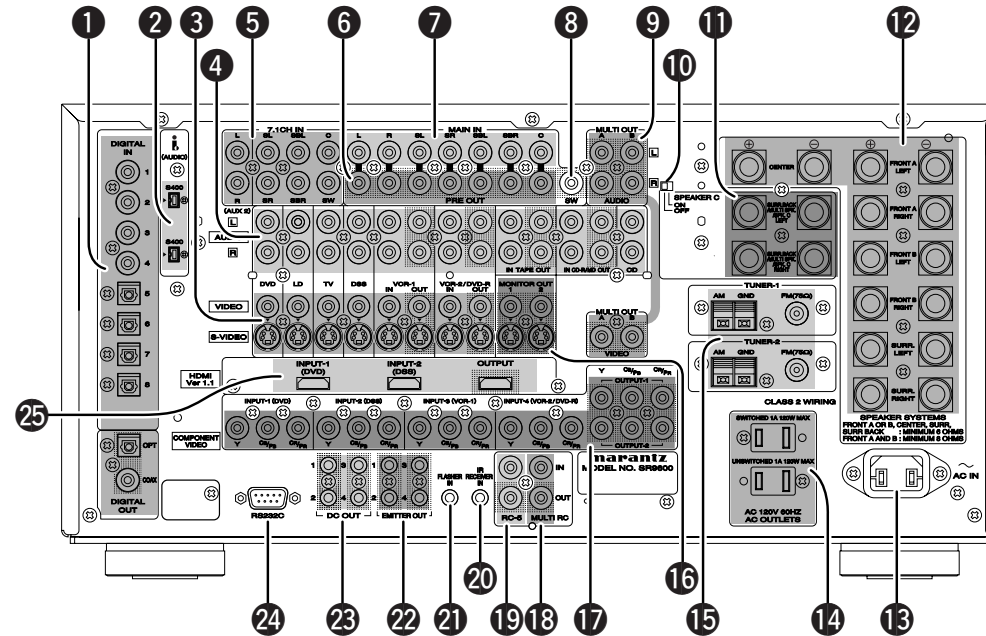

1 DIGITAL INPUT (Dig. 1 - 8)/ OUTPUT (coaxial, optical)

These are the digital audio inputs and outputs. There are 4 digital inputs with coaxial jacks, and 4 with optical jacks.

The inputs accept digital audio signals from a CD, LD, DVD, or other digital source component. For digital output, there is 1 coaxial output and 1 optical output.

The digital outputs can be connected to MD recorders, CD recorders, DAT decks, or other similar components.

2 i.LINK connector

Up to S400 (400 Mbps) i.LINK devices can be connected to this receiver.

3 VIDEO IN/OUT (DVD, LD, TV, DSS, VCR1, VCR2/DVD-R)

These are the video inputs and outputs.

There are 6 video inputs, and 2 video outputs with both composite video and S-video jack for each. Connect VCRs, DVD players, and other video components to the video inputs.

The 2 video output channels can be used to connect VCRs for making recordings.

4 AUDIO IN/OUT (DVD, LD, TV, CD, DSS, VCR1, VCR2/DVD-R, TAPE, CD-R/MD, CD)

These are the analog audio inputs and outputs.

There are 9 audio inputs (6 of which are linked to video inputs) and 4 audio outputs (2 of which are linked to video outputs). The audio jacks are labeled for cassette tape decks, CD players, DVD players, etc. The audio inputs and outputs require RCA connectors.

5 7.1 CHANNEL or AUX2 INPUT

By connecting a DVD Audio player, Super Audio CD multichannel player, or other components that has a multichannel port, you can play back the audio with 5.1 channel or 7.1 channel outputs.

6 Preamp Outputs (L, R, SL, SR, SBL, SBR, C)

Jacks for L (front left), R (front right), C (Center), SL (surround left), SR (surround right), SBL (surround back left) and SBR (surround back right).

Use these jacks for connecting to external power amplifiers.

7 Main amplifier inputs (L, R, SL, SR, SBL, SBR, C)

When the jumper plugs that link the preamp outputs with these inputs are removed, these jacks may be used to connect an external source to the internal amplifiers.

Notes:

- When connecting equipment, remove the attached jumper plugs and store them carefully so as not to lose them.
- Only remove the jumper plugs when required. After you finish using a main amp input jack, replace the jumper plug.

8 Subwoofer output

Connect this jack to the line level input of a powered subwoofer.

If an external subwoofer amplifier is used, connect this jack to the subwoofer amplifier input.

If you are using two subwoofers, either powered or with a 2 channel subwoofer amplifier, connect a "Y" connector to the subwoofer output jack and run one cable from it to each subwoofer amplifier.

9 Multiroom outputs (Audio L&R, Video)

These are the audio and video output jacks for the multiroom A and B systems.

Connect these jacks to optional audio power amplifiers or video display devices to listen and view the source selected by the multiroom A and B systems in a remote room.

10 SPEAKER C switch

Set to ON to connect a bi-amp to this receiver or set to OFF for normal speaker connection (surround back and multiroom speakers). (See page 27)

11 Speaker outputs (SURROUND BACK/MULTI SPEAKER/SPEAKER C)

Two terminals are provided for the front left, and right speakers for multiroom or surround back. The terminals can be used to connect a third set of speakers by setting the SPEAKER C switch to ON. (See page 27)

12 Speaker output

Seven terminals are provided for the front (A) left, front (A) right, front (B) left, front (B) right, front center, surround left and surround right speakers.

13 AC INLET

Plug the supplied power cord into this AC INLET and then into the power outlet on the wall. The SR9600 can be powered by 120 V AC only.

14 AC OUTLETS

Connect the AC power cables of components such as DVD and CD players to these outlets. "SWITCHED" and "UNSWITCHED" outlets are provided.

The one marked "SWITCHED" provides power only when the SR9600 is turned on and is useful for components which you use every time you play your system.

The one marked "UNSWITCHED" is always live as long as the SR9600 is plugged into a live outlet.

A component connected here may be left on permanently, or may be switched off with via its own power switch.

Caution:

- In order to avoid potential issues, anything plugged into these outlets should be powered up before the SR9600 is turned on.
- The capacity of this AC outlet is 120 W. Do not connect devices that consume electricity more than the capacity of these AC outlets. If the total power consumption of the connected devices exceeds the capacity, the protection circuit shuts down the power supply.

15 FM antenna 1, 2 (75 ohms)

Connect an external FM antenna with a coaxial cable, or a cable network FM source.

AM antenna and ground 1, 2

Connect the supplied AM loop antenna. Use the terminals marked "AM" and "GND". The supplied AM loop antenna will provide good AM reception in most areas. Position the loop antenna until you hear the best reception.

16 MONITOR OUT

These are the monitor outputs. Each one includes both composite video and S-video jacks. When connecting two video monitors or TVs, be aware that the OSD interface can be used with both MONITOR OUT connections.

17 COMPONENT VIDEO INPUT/OUTPUT

If your DVD player or other device has component video connectors, be sure to connect them to these connectors on the SR9600. The SR9600 has 4 component video input connectors to obtain the color information (Y, C_B/P_B, C_R/P_R) directly from the recorded DVD signal or other video component and 2 component video output connectors to output it directly into the matrix decoder of the display device.

By sending the pure DVD component video signal directly, the DVD signal forgoes the extra processing that normally would degrade the image. The result is vastly increased image quality, with incredibly life-like colors and crisp detail.

18 MULTIROOM REMOTE IN/OUT

IN: Connect to a multiroom remote control device, available from your Marantz dealer.

OUT: Connect to a Marantz component equipped with remote control (RC-5) terminals in a multiroom configuration.

19 REMOTE CONT. IN/OUT

Connect to a Marantz component equipped with remote control (RC-5) terminals.

20 IR RECEIVER IN

Connect to an external IR receiver.

21 FLASHER IN (Flasher input terminal)

These terminals are for controlling the unit from each room using a keypad, etc.

22 EMITTER OUT

The signals input to the IR RECEIVER IN terminals are output to this terminal. External devices can be controlled by connecting them to this terminal.

23 DC TRIGGER output

Connect a device that needs to be triggered by DC under certain conditions (screen, power strip, etc.) Use the OSD menu system to determine the conditions in which these jacks will be active. (See page 45)

Note:

- This output voltage is for status control only. It is not sufficient for drive capability.

24 RS232C

The RS232C port is used in conjunction with an external controller to control the operation of the SR9600 using an external device.

The RS232C port may also be used in the future to update the operating software of the SR9600 so that it will be able to support new digital audio formats and other feature as they are introduced.

25 HDMI INPUT/OUTPUT

This unit has 2 HDMI inputs and 1 HDMI output. The input function can be selected from the OSD menu system. (See page 24)

REMOTE CONTROLLER RC3200B

NAMES AND FUNCTIONS

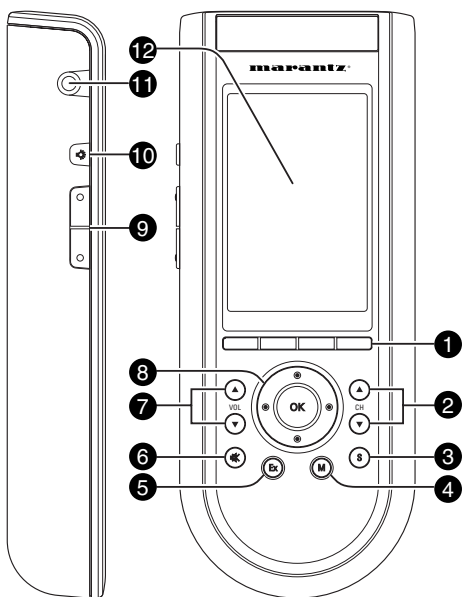

1 Select buttons for navigation bar

These buttons control the navigation bar in LCD touch screen. Each function may also be provided with an alphanumeric indicator visible in the navigation bar of LCD touch screen.

2 CH (Channel) ▲ up and ▼ down buttons

Press these buttons to select the SR9600 tuner presets or TV channels.

3 S (Status) button

Press this button to see the SR9600 status on the LCD touch screen.

4 M (Menu) button

Press this button to enter the OSD menu system.

5 Ex (Exit) button

Press this button to exit the OSD menu system.

6 Mute button

Press this button to mute the sound temporarily.

7 VOL (Volume) ▲ up and ▼ down buttons

Press these buttons to raise and lower the SR9600's volume level.

8 OK and cursor (Up/Down/Left/Right) buttons

Press these buttons to navigate through the OSD menu system. (Refer to "ON SCREEN DISPLAY MENU SYSTEM" on page 30)

9 Page up/down buttons

Press these buttons to scroll up or down the contents of LCD touch screen.

10 Backlight button

Press this button to turn on the backlight of the LCD touch screen.

11 Serial port

Connect the RC3200B with your computer using an RS232C cable for future upgrades.

12 LCD touch screen

The LCD touch screen is divided into different sections:



In this area, you can see the device you are operating.

Operate your device with these soft buttons.

LOADING BATTERIES

When you use RC3200B for the first time, you have to install the batteries.

The RC3200B requires 3 AA batteries (3 x 1.5 V) to function.

Note:

- The included batteries are for verifying functionality of the remote control unit. When replacing the batteries, either rechargeable or non-rechargeable batteries may be used.

1. Remove the back cover.

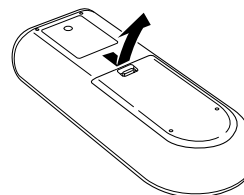

2. Insert the new batteries (AA type) with correct ⊕ and ⊖ polarity.

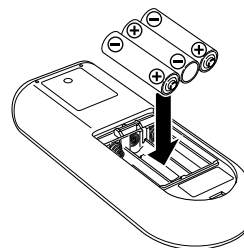

3. Close until it clicks.

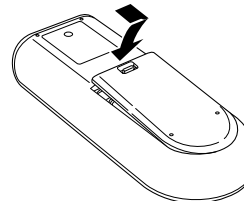

Notes:

- Do not mix alkaline and manganese batteries.
- Do not mix old and new batteries.

CAUTIONS ON BATTERIES

- Use "AA" (R6P) batteries in this remote control unit.
- If the remote control unit does not operate from close to the main unit, replace the batteries with new ones, even if less than a year has passed.
- The included battery is only for verifying operation. Replace it with a new battery as soon as possible.
- When inserting the batteries, be careful to do so in the proper direction, following the marks in the remote control unit's battery compartment.
 - To prevent damage or battery fluid leakage:
 - Do not use a new battery with an old one.
 - Do not use two different types of batteries.
 - Do not short-circuit, disassemble, heat or dispose of batteries in flames.
- Remove the batteries when not planning to use the remote control unit for a long period of time.
- If the batteries should leak, carefully wipe off the fluid from the inside of the battery compartment, then insert new batteries.
- When disposing of used batteries, please comply with governmental regulations or environmental public instruction's rules that apply in your country or area.

REMOTE-CONTROLLABLE RANGE

The distance between the transmitter/receiver of the remote control unit and the infrared sensor of the SR9600 should be less than about 16.4 ft (5 meters).

If the transmitter/receiver is pointed away from the infrared sensor or if there is an obstacle between them, remote control may not be possible.

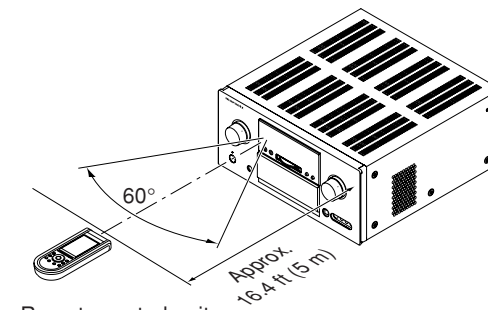

Remote control unit (RC3200B)

ACTIVATING THE RC3200B

When the RC3200B is switched on for the first time or when it is reset, the Introduction screen appears for a few seconds. The RC3200B then automatically switches to the Home screen that displays all available devices on your RC3200B. You can return to this Home screen from within other screens by pressing the **Home** button.

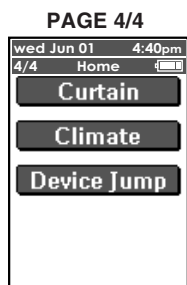
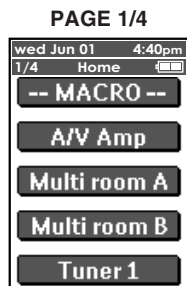

TURNING ON THE DISPLAY AND THE BACKLIGHT

RC3200B's display can be activated in two different ways: Tap the LCD touch screen gently with your finger or a blunt, soft object like a pencil eraser. The display is activated.

1. Press the **Backlight** (☼) button. The display and the backlight are activated. If the LCD touch screen stays blank or becomes black when turning on the display, read the next section "**CHANGING THE LCD CONTRAST**" to adjust the contrast of the LCD touch screen.

Notes:

- RC3200B has a timeout feature: the LCD touch screen and the backlight automatically turn off to save power.
- Refer to "**ADJUSTING THE SETTINGS**" on page 17 to adjust the timeout for the LCD and the backlight.

CHANGING THE LCD CONTRAST

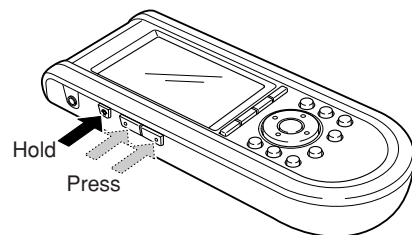

1. Press and hold the **Backlight** (☼) button. The screen lights up.
2. While still holding the **Backlight** (☼) button, press the **page up** button once to increase the LCD contrast one level. The LCD contrast is adjusted one level up. or press the **page down** button once to decrease the LCD contrast one level. The LCD contrast is adjusted one level down.
3. Release the **Backlight** (☼) button when the contrast is satisfactory. The LCD contrast can be adjusted 16 levels.

Notes:

- To adjust the contrast multiple levels, you have press the **page up** or **page down** button multiple times.
- When you press and hold the **page up** or **page down** button, the LCD contrast will only change one level.

THE BATTERY STATUS

The battery icon (🔋) indicates the status of your batteries.

When the battery status is low, the low battery icon (🔋^{Low}) appears at the top of the LCD touch screen. You can still operate your devices, but you cannot adjust the settings, learn commands or record macros anymore.

OPERATING DEVICES

To operate devices on your RC3200B you have to switch to the Home screen.

This screen displays the available devices such as TV, VCR, DVD, Amp, etc.

ACTIVATING THE HOME SCREEN

Press the **Home** button.

The Home screen appears, showing the available devices on the RC3200B.

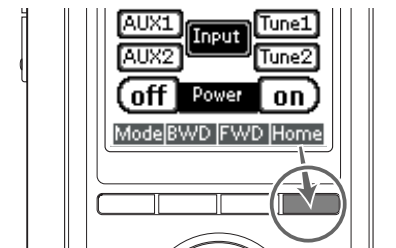

SELECTING A DEVICE ON THE HOME SCREEN

Tap the soft button of the device you want to operate. The first page of the selected device appears. Use the **page up** and **page down** buttons to go to another page of the device.

You can operate devices using the buttons on your RC3200B:

- **Soft buttons (touch screen buttons);**
- **Hard buttons.**

USING THE SOFT BUTTONS

By tapping the soft buttons on the LCD touch screen you can send IR commands to the device you have selected.

The name of the active device is indicated at the top of the LCD touch screen.

Note:

- You can operate the soft buttons in the same way as you would operate hard buttons on a conventional remote control. If you keep the soft button pressed instead of tapping it, the RC3200B keeps sending the IR command.

A/V AMP

To control the SR9600 from your RC3200B, you have to select the A/V AMP on Home screen.

SOURCE SELECT (PAGE 1/8)**7.1 Input on and off**

These buttons are used to select 7.1 ch input source. (see page 57)

DVD, TV, CD,
VCR1, VCR2, DSS,
CD-R, LD, Tape,
AUX1, Tune1,
AUX2, Tune2

These buttons are used for selecting an input source. (see page 48)

Input

These buttons are used to change the input source.

Power on and off

These buttons are used to turn the SR9600 on or off.

SURROUND MODE 1 (PAGE 2/8)

AUTO,
Stereo, M-Stereo,
S-Direct, P-Direct,
THX mode,
EX / dts ES ,
Virtual, Mode

These buttons are used to select the surround mode. (see page 49)

SURROUND MODE 2 (PAGE 3/8)

THX
Surr.EX, Ultra 2,
Cine, Games, Music

These buttons are used to select the THX mode. (see page 49)

DTS
dts Mode, dts ES,
Neo6-Cine and Neo6-music

These buttons are used to select the DTS mode. (see page 49)

SURROUND MODE 3 (PAGE 4/8)**Dolby Surround**

□□

PLIIx

PLIIx-movie, PLIIx-Game, PLIIx-music,
□□ Dolby Headphone

These buttons are used to select Dolby Surround mode. (see page 49)

Circle Surround II

CSII-Cine, CSII-Mono, CSII-music

These buttons are used to select SRS Circle Surround mode. (see page 49)

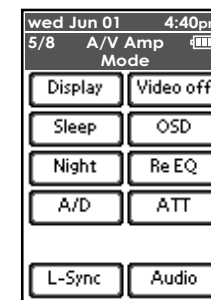
MODE (PAGE 5/8)**Display**

This button is used to select the display mode for main display. (see page 56)

Video off

This button is used to turn off or on the video signal outputs from the MONITOR OUT terminals. (see page 56)

Sleep

This button is used to set the sleep timer. (see page 49)

OSD

This button is used to turn on the OSD menu system for general information.

You can view the status of the SR9600.

Night

This button is used to set the night mode. (see page 50)

Re-EQ

This button is used to activate the Cinema Re-EQ™. Press it again to deactivate. (see page 50)

A/D

This button is used to select the Auto digital input, fixed digital input or analog input. (see page 56)

ATT

This button is used to attenuate the analog input signals. (see page 55)

L-Sync

This button is used to activate the LIP.SYNC control mode. (See page 50)

Audio

This button is used to set the audio to Dolby Digital, dts or bilingual broadcasts.

MAIN → SUB → MAIN + SUB → MAIN

tone adjust (PAGE 6/8)

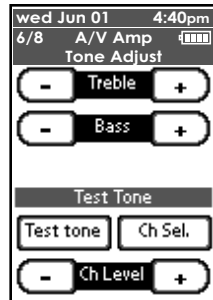

Treble + and -

These buttons are used to adjust the tone of high-frequency sound. (see page 49)

Bass + and -

These buttons are used to adjust the tone of low-frequency sound. (see page 49)

Test tone

This button is used to generate a test tone noise signal. You can check the balance of the output signal levels.

If this button is pressed during normal operation, the test tone display of the OSD menu system appears on the display. (See page 39)

Ch Sel.

This button is used to change the test tone noise signal output channel.

If this button is pressed during normal operation, a display for setting the output level for each channel appears on the display.

Ch Level + and -

This button is used to adjust the output level of each channel.

SPEAKER A/B (PAGE 7/8)

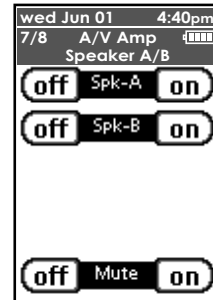

Spk-A on and off

These buttons are used to turn speakers A on and off.

Spk-B on and off

These buttons are used to turn speakers B on and off.

Mute on and off

These buttons are used to turn the mute on and off.

DC TRIGGER (PAGE 8/8)

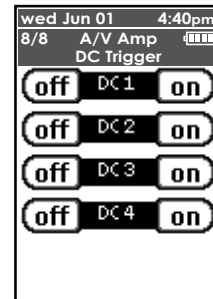

DC trigger on and off (1,2,3,4)

These buttons are used to turn the four DC trigger outputs on and off. Trigger control must first be set on the OSD menu system. (see page 45)

MULTI ROOM A/B

MULTI ROOM A/B (PAGE 1/6)

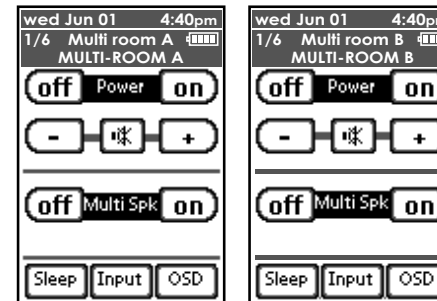

Power on and off

These buttons are used to switch the unit to the multiroom mode.

Volume + and -

These buttons are used to adjust the sound level in the multiroom system.

Mute

This button is used to mute the sound in the multiroom system temporarily.

Multi Spk On and Off

These buttons are used to switch the unit to the multiroom speaker mode.

Sleep

This button is used to set the sleep timer in the multiroom system.

Input

This button is used to jump to the page 2/6 display.

OSD

This button is used to turn on the OSD menu system for general information.

Note:

- See page 61 to detail of Multi Room system.

MULTI ROOM A/B SOURCE (PAGE 2/6)

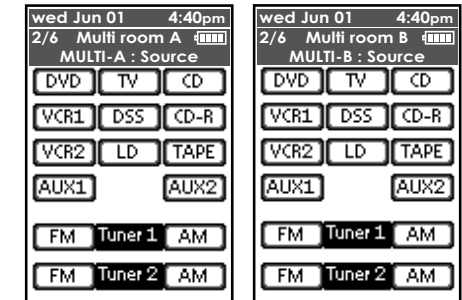

DVD, TV, CD, VCR1, DSS, CD-R, VCR2, LD, TAPE, AUX1, AUX2

These buttons are used for selecting an input source.

Tuner 1 FM and AM

These buttons are used to switch between the FM and AM mode of the tuner 1.

Tuner 2 FM and AM

These buttons are used to switch between the FM and AM mode of the tuner 2.

MULTI ROOM A/B TUNER 1 (PAGE 3/6)

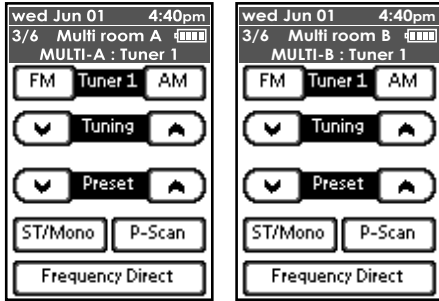

Tuner 1 FM and AM

These buttons are used to switch between the FM and AM mode of the tuner 1.

Tuning (▲ :up / ▼ : down)

These buttons are used to change the frequency.

Preset (▲ :up / ▼ : down)

These buttons are used to change the preset station.

ST/Mono

This button is used to set the FM tuning mode, auto stereo or mono.

P-Scan (Preset Scan)

This button is used to start scanning automatically through preset stations in the receiver's memory.

Frequency Direct

This button is used to jump to the page 4/6 display.

MULTI ROOM A/B TUNER 1 KEY (PAGE 4/6)

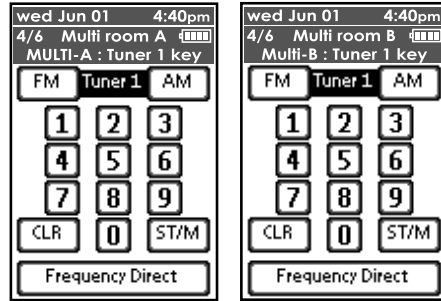

Tuner 1 FM and AM

These buttons are used to switch between the FM and AM mode of the tuner 1.

Ten-digit keypad (0, 1 - 9)

These buttons are used to change the preset station name or input a frequency directly.

CLR (Clear)

This button is used to cancel certain memory or programming operations.

ST/M

This button is used to set the FM tuning mode, auto stereo or mono.

Frequency Direct

This button is used to select the mode of frequency direct input.

MULTI ROOM A/B TUNER 2 (PAGE 5/6)

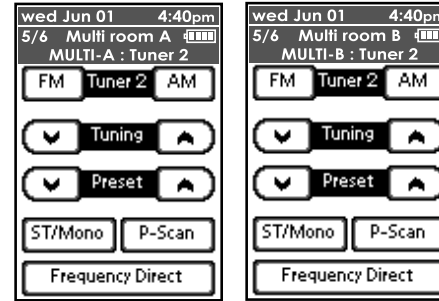

Tuner 2 FM and AM

These buttons are used to switch between the FM and AM mode of the tuner 2.

Tuning (▲ :up / ▼ : down)

These buttons are used to change the frequency.

Preset (▲ :up / ▼ : down)

These buttons are used to change the preset station.

ST/Mono

This button is used to set the FM tuning mode, auto stereo or mono.

P-Scan (Preset Scan)

This button is used to start scanning automatically through preset stations in the receiver's memory.

Frequency Direct

This button is used to jump to the page 6/6 display.

MULTI ROOM A/B TUNER 2 KEY (PAGE 6/6)

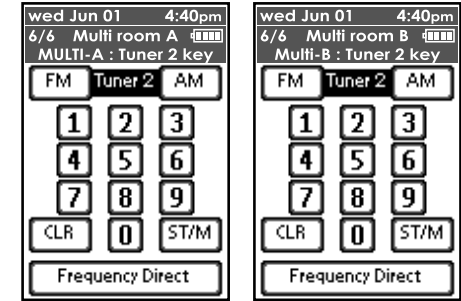

Tuner 2 FM and AM

These buttons are used to switch between the FM and AM mode of the tuner 2.

Ten-digit keypad (0, 1 - 9)

These buttons are used to change the preset station name or input a frequency directly.

CLR (Clear)

This button is used to cancel certain memory or programming operations.

ST/M

This button is used to set the FM tuning mode, auto stereo or mono.

Frequency Direct

This button is used to select the mode of frequency direct input.

TUNER 1/2

TUNER 1/2 : MAIN (PAGE 1/2)

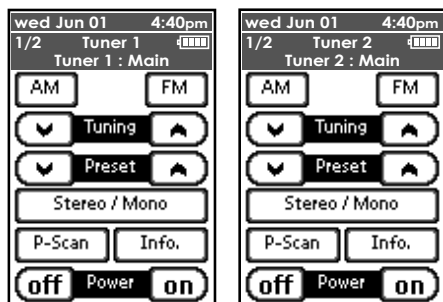

AM/FM

These buttons are used to switch between the the FM and AM mode of the tuner.

Tuning (▲ :up / ▼ : down)

These buttons are used to change the frequency.

Preset (▲ :up / ▼ : down)

These buttons are used to change the preset station.

Stereo/Mono

This button is used to set the FM tuning mode, auto stereo or mono.

P-Scan (Preset Scan)

This button is used to start scanning automatically through preset stations in the receiver's memory.

Info.

This button is used to display a list of preset stations on the OSD menu system.

Power on and off

These buttons are used to turn the SR9600 on or off.

TUNER 1/2 : KEY/RDS (PAGE 2/2)

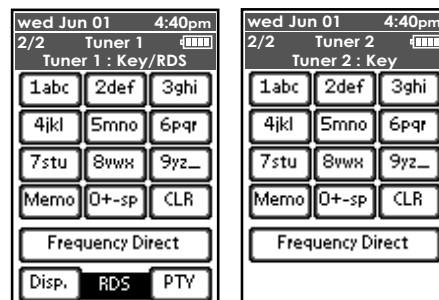

Ten-digit keypad (0, 1 - 9)

These buttons are used to change the preset station name or input a frequency directly.

Memo

This button is used to enter the tuner's preset memory numbers and station names.

CLR (Clear)

This button is used to cancel certain memory or programming operations.

Frequency Direct

This button is used to select the mode of frequency direct input.

RDS Disp.

(Europe model only)

RDS PTY

(Europe model only)

RECORDING MACROS

A macro allows you to send a sequence of commands using a single button. You can, for instance, switch on your TV, turn to a movie channel and prepare your VCR for recording by rewinding the videotape all from a single button on your RC3200B.

To record macros, the RC3200B has to be in the Macro mode.

1. Set the RC3200B to the Use Mode. See "WORKING WITH MODES". (see page 17)
2. Press the **Home** button.



3. Tap the **MACRO**.
The Macro screen appears.



4. Press and hold the **Mode** button for 3 seconds.
The Mode screen appears.



5. Tap the **MACRO** on the Mode screen.
A message screen appears.
The RC3200B is now in the Macro mode.

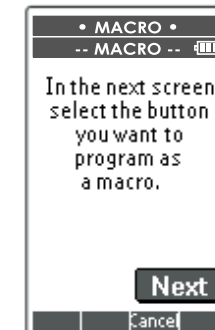

6. Tap **Next**.
The device screen with Macro labels appears.



Press the **page up** and **page down** buttons to go to other screens of the selected device.

7. Tap the soft button you want to select as a macro.
A message screen appears.



8. Tap **Start**.
The Home screen appears with the "RECORDING" label at the top of the screen. The buttons you tap on this screen will not be recorded. From the Home screen you can go to the different devices or you can press the **Extra** button to go to the EXTRA screen to set delays and beeps.

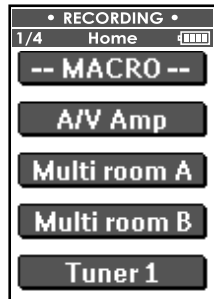

9. Tap the soft button of the device you want to go to.
The device screen appears.



10. Tap the soft or hard buttons of the commands you want to record.
11. Press the **page up** and **page down** buttons to go to different screens of the same device or press the **Home** button to go to the Home screen again.
12. To add delays and beeps to the macro, press the **Extra** button on the Home screen. The EXTRA screen appears.

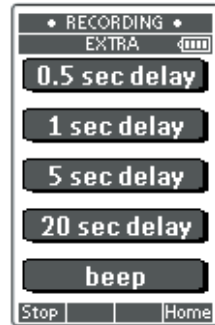

- 1) To add a delay, tap one of the delay buttons. By tapping several delay buttons, the duration of the delay will be increased.
2) To add a beep, tap the **beep**.
3) Press the **Home** button to go to the Home screen again.
13. Press **Stop** button to stop recording. A message screen appears.

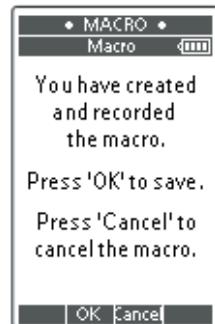

14. Press **OK** button to save the macro and return to the Mode screen. The existing command of the selected button is replaced by the macro. To return to the Mode screen without saving the macro, press **Cancel** button. The button retains its previous command.
15. Set the RC3200B to the Use mode to test the recorded macro.

SHOW THE SR9600 STATUS ON THE RC3200B

The RC3200B communication with the SR9600 is capable of two-way. It can display the status of the SR9600.

1/2 STATUS

To go to the first page of status screen, press the **S** button.

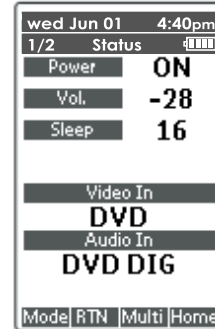

This status screen shows the power condition, volume level, sleep timer, video input, and audio input in the main room.

2/2 STATUS

To go to the second page of status screen, press **page up** button.

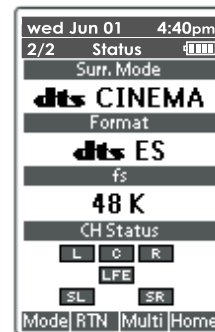

This status screen shows the surround mode, format and channel status of the input signal, in the main room.

MULTIROOM A STATUS

To go to the Multiroom status screen, press **Multi** button.

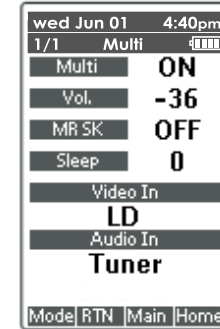

This status screen shows multiroom condition, volume level, sleep timer, video input, and audio input in the multiroom location.

To exit from the status screen, press the **RTN** button.

Note:

- This feature works only with Multiroom A.

WORKING WITH MODES

RC3200B starts up in the Use mode. This mode is for operating devices. For customizing the RC3200B (adjusting the settings, learning buttons or recording macros), you have to switch to the appropriate mode.

Note:

- When switching between modes, you will always return to the last active screen.

The RC3200B can be put into 4 different modes. These modes are:

- Use mode:** For operating your devices. See “OPERATING DEVICE” for more details.
- Setup mode:** For changing the RC3200B system settings. See “ADJUSTING THE SETTING” for more details.
- Learn mode:** For learning commands from other remote controls. See “LEARNING COMMANDS” for more details.
- Macro mode:** For recording macros. You can assign multiple commands to a single button. See “RECORDING MACROS” for more details.

Note:

- Learning commands and recording macros is only possible per device. This means that you first have to select a specific device to perform these actions.

1. On the **Home** screen tap the soft button of the device you want to customize. The first page of the selected device appears.
2. Press and hold the **Mode** button for 3 seconds. The Mode screen appears.



Note:

You have to press and hold the **Mode** button for 3 seconds to prevent accidental changes.

3. Select the desired mode from the Mode screen.

Note:

- When you switch to another mode from the Home screen, you cannot choose the Learn mode and Macro mode. To switch to these modes you first have to go to the specific device you want to customize.

ADJUSTING THE SETTINGS

The RC3200B settings can be adjusted in the Setup mode.

1. Press and hold the **Mode** button for 3 seconds. The Mode screen appears.
2. Tap the **Setup** on the Mode screen. The first Setup page appears.

The RC3200B settings consist of 3 setup pages with several settings per page. Use the **page up** and **page down** buttons to navigate to the appropriate setup page.

FIRST SETUP PAGE

On the first setup page you can adjust:

- **LCD (LCD timeout)**
- **Backlight (backlight timeout)**
- **Beep volume**

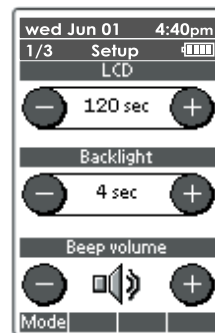

Adjust the LCD timeout

The LCD timeout indicates how long the LCD touch screen stays active before it turns off. The LCD will only time out when you don't touch any buttons.

You can set the timeout between 1 second and 120 seconds.

Press “+” to increase or “-” to decrease the time the LCD stays active.

1. Tap “+” or “-” once to adjust the timeout 1 second up or down.
2. Press and hold “+” or “-” to adjust the timeout in 10 second increments up or down.

Adjust the backlight timeout

The backlight setting indicates how long the backlight of the LCD touch screen and the buttons stay active.

The backlight timeout can be set between 1 second and 120 seconds.

Note:

- The backlight cannot stay active longer than the LCD. If you increase the backlight timeout, the LCD timeout will automatically increase as well. Press “+” to increase or “-” to decrease the time the backlight stays active.

1. Tap “+” or “-” once to adjust the timeout 1 second up or down.
2. Press and hold “+” or “-” to adjust the timeout in 10 second increments up or down.

Note:

- When the settings for the LCD timeout and the backlight timeout are high, the battery lifetime may be reduced.

Change the Beep Volume

The beep volume setting adjusts or turns off the volume of all button and system beeps on the RC3200B. The beep volume levels are mute, soft, medium and loud.

1. Press “+” to increase or “-” to decrease the beep volume.

SECOND SETUP PAGE

On the second setup page you can adjust:

- **Date**
- **Time**

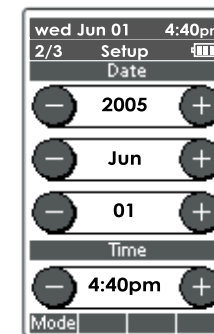

Adjust the Date

You can set the year, the month and the day in the date settings.

Press “+” to increase or “-” to decrease the value for the year, month and day.

1. Tap “+” or “-” once to adjust the year, month and day one value up or down.
2. Press and hold “+” or “-” to adjust the values for the year and the month more rapidly. The value for the day settings will change in 5 day increments.

The RC3200B will immediately reflect the date change at the top of the screen.

Adjust the Time

1. Tap "+" or "-" once to adjust the time 1 minute up or down.
2. Press and hold "+" or "-" to adjust the time more rapidly. The time will increase or decrease in 30 minute increments.

The RC3200B will immediately reflect the time change at the top of the screen.

THIRD SETUP PAGE

RC3200B Information



This page contains information that may be important to the dealer in case of a defect. The following information is displayed on this screen:

- Free memory (in percentage), which gives you an indication on how much memory is left to (further) customize the RC3200B.
- Boot version
- Application version
- Configuration file

CALIBRATE

Calibrate the LCD touch screen if the position you touch on the screen does not match the intended display position.

1. Tap the **Calibrate**.
A message screen appears that "Touch the top left corner".

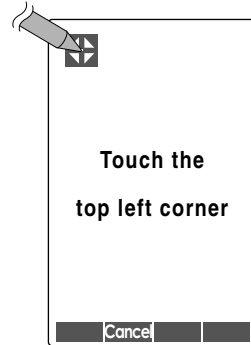

Tap the + point.

2. A message screen appear that "Touch the bottom right corner".

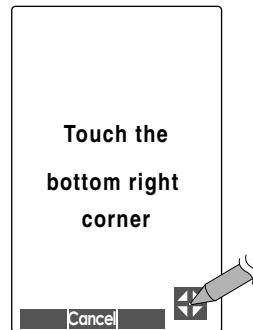

Tap the + point.

3. Calibration is successful.

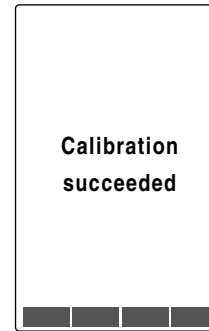
**REVERT****Warning:**

- When you revert the RC3200B, all customization is lost permanently. You lose all RC3200B settings, learned codes and recorded macros.

By tapping the **Revert**, the RC3200B will be returned to the default configuration. Reverting to the original configuration restores the RC3200B to its initial state. You might have to revert when you notice that scrolling through pages is slowing down. This may occur if you have added a lot of commands to the RC3200B.

1. Tap the **Revert**.
A message screen appears, asking you to confirm or cancel the revert process.



2. Press **OK** or **Cancel**.

TO EXIT SETUP MODE

1. Press the **Mode** button.
The Mode screen appears.
2. Tap the **Mode** you want to go to. The RC3200B switches to this mode. See also "**WORKING WITH MODE**". (See page 17)

LEARNING COMMANDS

If an IR code or a brand is not in the database, you can program RC3200B commands by transmitting IR signals from your existing remote control units to the RC3200B's learning eye. To do this, place the RC3200B and the device's remote control unit on a flat surface, 1 - 4 inches (2.5 - 10 cm) apart.

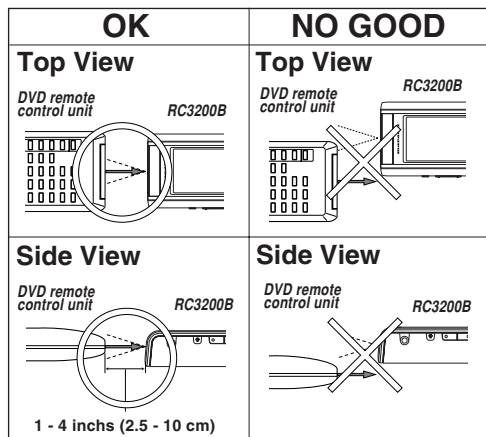

To learn commands from other remote control units, RC3200B has to be in Learn mode. Switching to Learn mode is only possible from the Mode screen.

See "WORKING WITH MODES". (See page 17)

For each device, you can learn all soft and hard buttons on the RC3200B, except for:

- the BACKLIGHT button
- the page up and page down buttons
- the buttons to navigation bar
- the S button

THE LEARN SEQUENCE

1. Set the RC3200B to the Use mode. See "WORKING WITH MODES".
2. Select the device, e.g. DVD, with the buttons you want to learn. The device screen appears.
3. Press and hold the **Mode** button for 3 seconds. The Mode screen appears.
4. Tap **Learn** on the Mode screen.



The RC3200B is now in the Learn mode. "LEARN" and the label of the selected device appear at the top of the LCD touch screen.

5. Use, if necessary, the **page up** or **page down** button to go to the next button you want to learn.

6. Press the soft or hard button you want to learn on the RC3200B.

The "LEARN" label changes to "LEARNING", which means RC3200B is ready to receive commands from an existing remote control unit.

The RC3200B will wait for 5 seconds to receive an IR code from another remote control unit.

Note:

When a hard button is pressed to learn, there is no onscreen feedback to indicate which button is pressed.

7. Press and hold the button on the existing remote control unit you want to learn to the RC3200B.

When the RC3200B receives an IR code:

- A confirmation beep will sound.
- The label changes from "LEARNING" to "OK". The learn sequence is successful.

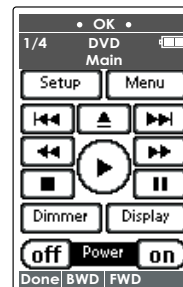

When the RC3200B does not receive an IR code within 5 seconds:

- An error beep will sound.
- The label changes from "LEARNING" to "FAILED". The learn sequence has failed.
- The RC3200B will return to the Learn mode. Return to step 5 of the learn sequence to relearn the button.

Tip:

You do not have to wait for the "OK" or "FAILED" to disappear. If you press another button (soft or hard), the RC3200B learn sequence immediately goes back to step 5.

8. Go to other pages of the selected device with the **page up** and **page down** buttons.

Repeat steps 6 and 7 until you have copied all the commands of the existing remote control.

9. Press **Done** button when you have finished learning commands on the buttons of your choice.

The RC3200B returns to the Use mode. You can try out the new IR codes or select another device to learn.

RC3200B SETUP

If you want to personalize your RC3200B even more beyond its standard programming features, RC3200Setup is the tool to use.

You can find more information and updates to the software at "<http://www.marantz.com>". RC3200Setup is a visual editor for creating and configuring RC3200B Configuration Files (NCF) on your computer. An NCF is a file that is used to define the RC3200B behavior and appearance of the LCD touch screen.

Note:

- It is advised to make backup copies of your own configurations. This can be done with RC3200Setup.

With RC3200Setup you can:

- generate a Home screen;
- design the page layout and the appearance of buttons;
- configure the behavior of the hard and soft buttons;
- access RC3200Setup's extended help system by pressing **F1**.
- save, duplicate and share NCFs, devices, buttons, bitmaps or codes with another RC3200B;
- preview the NCF on the RC3200B emulator;
- download new configurations to your RC3200B using the included serial cable.

- Plug one end of the serial cable in the serial port on your computer.
- Plug the other end of the serial cable into the serial port on the RC3200B.

Note:

- When the RC3200B is connected to a PC, the battery lifetime may be reduced.

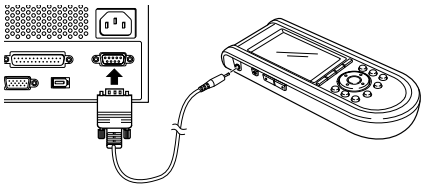

MINIMUM SYSTEM REQUIREMENTS

- PC with a Pentium 166 MHz or higher processor
- Windows 95/98/ME/XP or NT 4.0/2000
- 32 MB of RAM
- 16 MB of free hard disk space
- Free serial port

Notes:

- Microsoft and Windows are trademarks of the Microsoft Corporation of the U.S.A. and are registered in the U.S. and other countries.
- Pentium is a trademark of Intel Corporation in the U.S. and other countries.

IMPORTANT NOTICES

Take care not to scratch the LCD touch screen

Use your finger to tap the LCD touch screen or use plastic-tipped pens intended for use with touch screens.

Never use an actual pen, pencil or other sharp object on the LCD touch screen.

Protect the RC3200B from extreme temperatures

Keep the RC3200B away from heaters and other heat sources.

The RC3200B is not waterproof

The RC3200B should not be exposed to rain or moisture.

Do not store or use the RC3200B in any location that is extremely damp or wet.

If you spill water on the RC3200B, take out the batteries and let the RC3200B dry for 48 hours before reinserting the batteries.

If you spill other liquids like coffee on the RC3200B, clean it with distilled water. Make sure no water gets into the housing.

The touch screen of RC3200B contains a glass element

Do not drop the RC3200B or subject it to any strong impact.

Replace batteries

The RC3200B has a backup function to prevent some memory data such as learned RC codes, macros from being erased when the batteries are replaced.

However, the setup page memory (LCD, lighting, date, etc.) will be cleared.

Please reset these contents, after inserting new batteries.

CLEANING RC3200B

Use a soft, damp cloth to clean RC3200B.

If the LCD touch screen of RC3200B is spoiled, clean it with a soft cloth moistened with a diluted window-cleaning solution.

Do not use a corrosive detergent or an abrasive sponge.

Avoid the use of abundant water.

HOW TO RESET THE RC3200B

Under normal circumstances, you will never have to reset the RC3200B.

However, on rare occasions, if the RC3200B's touch screen freezes or if you notice unusual behavior, you need to perform a reset to get the RC3200B running again. All customized commands and devices are retained.

- Slide the battery cover off the back of the RC3200B.
You will see the **Reset** button in the battery compartment.
- Use an unfolded paperclip to carefully press the **Reset** button.
The RC3200B restarts and the Introduction screen appears. The RC3200B beeps twice to indicate it is ready for use.

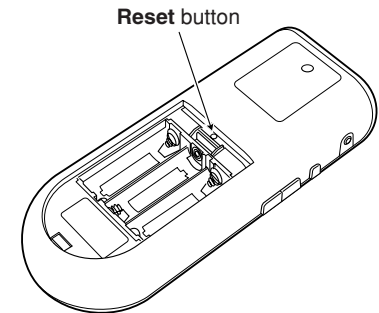

CONNECTIONS

SPEAKER PLACEMENT

The ideal surround speaker setup for this unit is 8-speaker, using front left and right speakers, a center speaker, surround left and right speakers, surround back left and right speakers, and a subwoofer.

For best results we recommend that all front speakers be of the same type, with identical or similar driver units. This will deliver smooth pans across the front sound stage as the action moves from side to side.

Your center channel speaker is very important as over 80% of the dialog from a typical motion picture emanates from the center channel.

It should possess similar sonic characteristics to the main speakers. Surround channel speakers need not be identical to the front channel speakers, but they should be of high quality.

The surround speaker is useful for playback of Dolby Digital Surround EX or DTS-ES. One of the benefits of both Dolby Digital and DTS is that surround channels are discrete full range, while they were frequency-limited in earlier "Pro Logic" systems.

Bass effects are an important part of home theater. For optimal enjoyment a subwoofer should be used as it is optimized for low frequency reproduction. If you have full range front speakers, however, they may be used in place of a subwoofer with proper setting of the switches in the menu system.

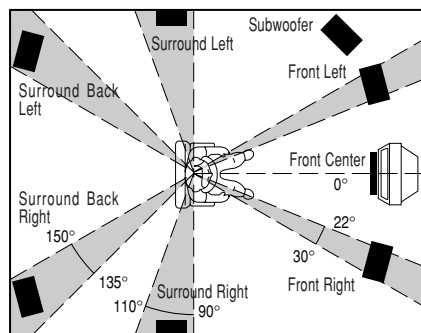

Front left and right speakers

We recommend setting the front left and right speakers 45-60 degrees from the listening position.

Center speaker

Align the front line of the center speaker with the front left and right speakers. Or, place the center speaker a little back from the line.

Surround left and right speakers

When the SR9600 is used in a surround setup, the preferred location for the surround speakers is on the side walls of the room, at or slightly behind the listening position.

The center of the speaker should face into the room.

Surround back left and right speakers

Surround back speakers are required when a full 7.1-channel system is installed.

Speakers should be placed on a rear wall, behind the listening position.

The center of the speaker should face into the room.

Subwoofer

We recommend using a subwoofer to have maximum bass effect. Subwoofer bears only low frequency range so you can place it anywhere in the room.

HEIGHT OF THE SPEAKER UNITS

Front left and right speakers, and a center speaker

Align the tweeters and mid-range drivers on the three front speakers at the same height, as best as possible.

Surround left and right speakers, and surround back speaker

Place the surround left, right and surround back speakers higher than your ears by about 2.3 - 3.3 ft (70cm-1m). Also, place the speakers at the same height, as best as possible.

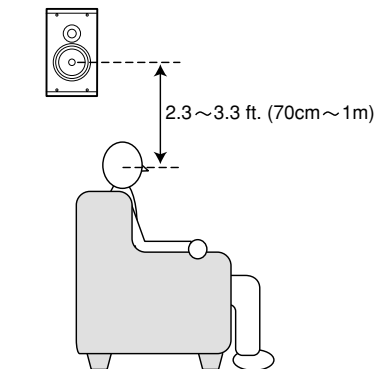

Note:

- Use magnetically-shielded speakers for front left, front right and center speakers when the speakers are installed near the TV CRT.

CONNECTING SPEAKERS

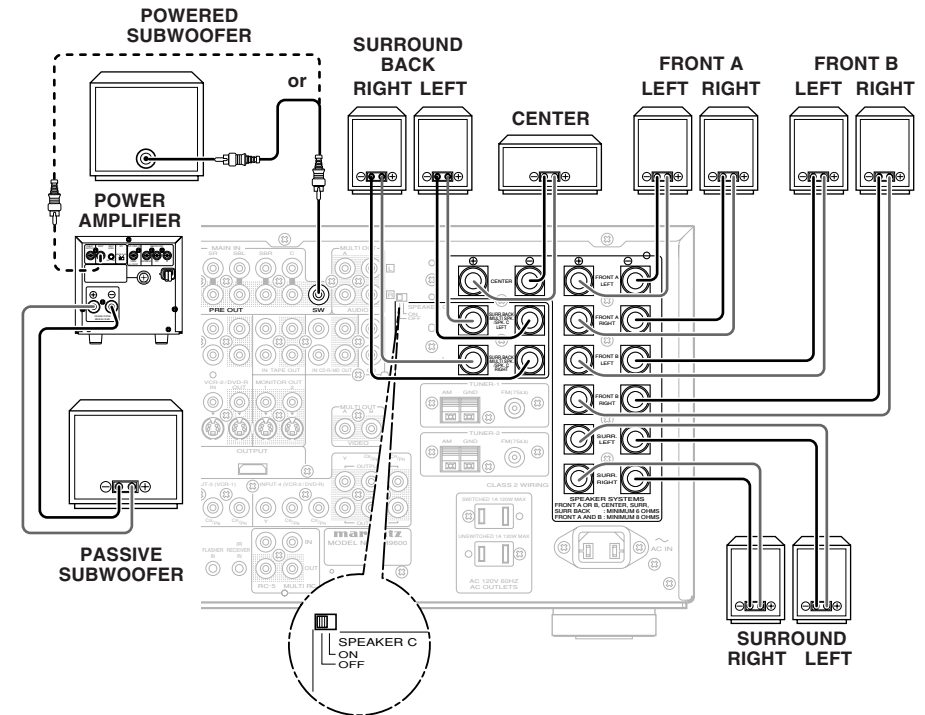

CONNECTING A SUBWOOFER

Use the PRE OUT SUBWOOFER jack to connect a powered subwoofer (the power amplifier is built in). If your subwoofer is a passive type (the power amplifier is not built in), connect a monaural power amplifier to the PRE OUT SUBWOOFER jack and connect the subwoofer to the amplifier.

CONNECTING SPEAKER WIRE

1. Strip away approx. 3/8 inch (10 mm) of wire insulation.
2. Twist the bared wire ends tight, to prevent short circuits.
3. Loosen the knob by turning it counterclockwise.
4. Insert the bare part of the wire into the hole inside each terminal.
5. Tighten the knob by turning it clockwise to secure the wire.

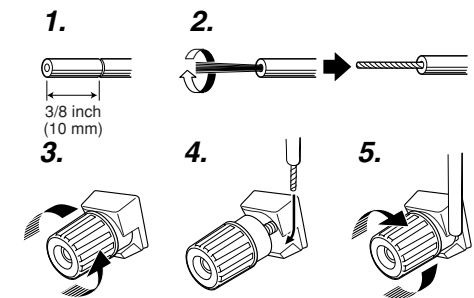

Caution:

- Be sure to use speakers with the specified impedance as shown on the rear panel of the SR9600.
- To prevent damage to circuitry, do not let the bare speaker wires touch each other and do not let them touch any metal part of the SR9600.
- Do not touch the speaker terminals when the power is on. It may result in an electric shock.
- Do not connect more than one speaker cable to one speaker terminal. Doing so may damage the SR9600.

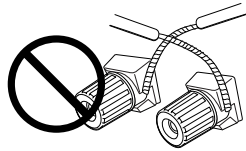

Note:

- Be sure to connect the positive and negative cables for the speaker properly. If they are misconnected, the signal phase will be reversed and the signal quality will be corrupted.

CONNECTING AUDIO COMPONENTS

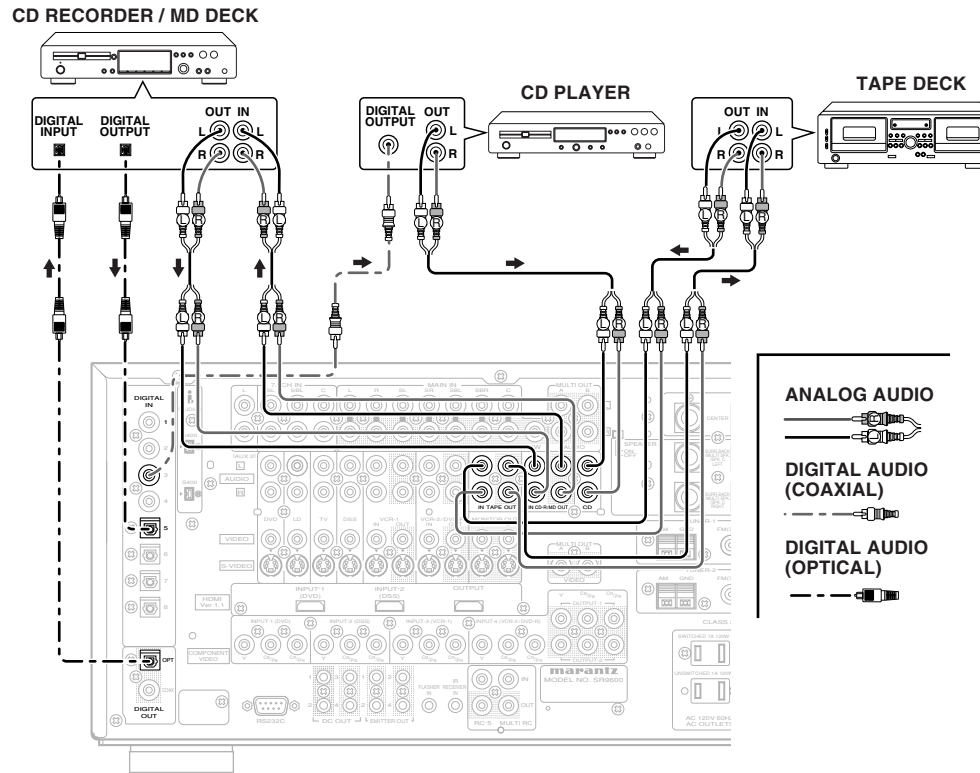

The output audio signal from the TAPE OUT jack and the CD-R/MD OUT jack is the same signal which is currently selected.

Caution:

- Do not connect the SR9600 and other components to a power outlet until all connections between components have been completed.

Notes:

- Insert all plugs and connectors securely. Incomplete connections may make noise.
- Be sure to connect the left and right channels properly.
Red connectors are for the R (right) channel, and white connectors are for the L (left) channel.
- Be sure to connect inputs and outputs properly.
- Refer to the instructions for each component that is connected to the SR9600.
- Do not bind audio/video connection cables with power cords and speaker cables. This will result in a hum or other noise.

CONNECTING DIGITAL AUDIO COMPONENTS

- There are 8 digital inputs, 4 coaxial jacks and 4 optical jacks on the rear panel. You can use these jacks to input PCM, Dolby Digital and DTS bitstream signals from a CD, DVD, or other digital source component.
- There is one digital output coaxial jack and one optical output jack on the rear panel. These jacks can be connected to CD recorder, or MD deck inputs, respectively.
- Refer to the instructions for each component to setup the digital audio format of a DVD player, or other digital source connected to digital input jacks.
- Use 75 ohm coaxial cables (for digital audio or video) for the DIG-1, 2, 3, 4 input jacks. Use fiberoptic cables (optical) for the DIG-5, 6, 7, 8 input jacks.
- You can designate the input for each set of digital input/output jacks according to your component. (see page 33)

Notes:

- There is no Dolby Digital RF input jack. Use an external RF demodulator Dolby Digital decoder when connecting the Dolby Digital RF output jack of the videodisc player to the digital input jack.
- The digital signal jacks on this unit conform to the EIA standard. If you use a cable that does not conform to this standard, this unit may not function properly.
- Each type of audio jack works independently. Signals input through the digital and analog jacks are output through the corresponding digital and analog jacks, respectively.

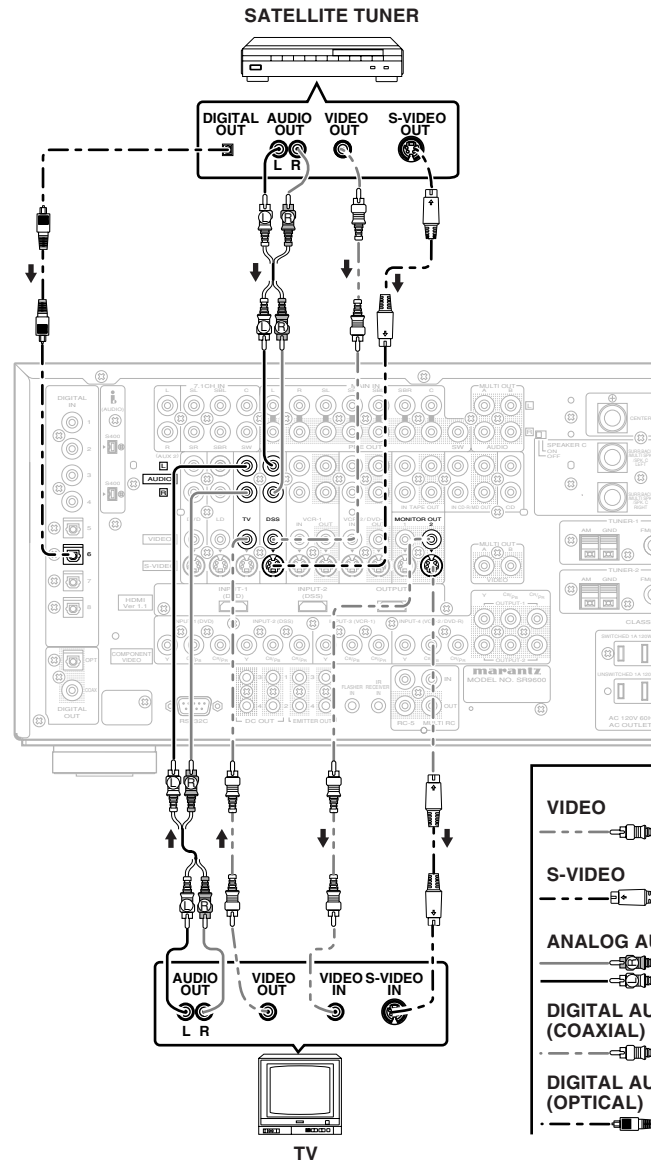
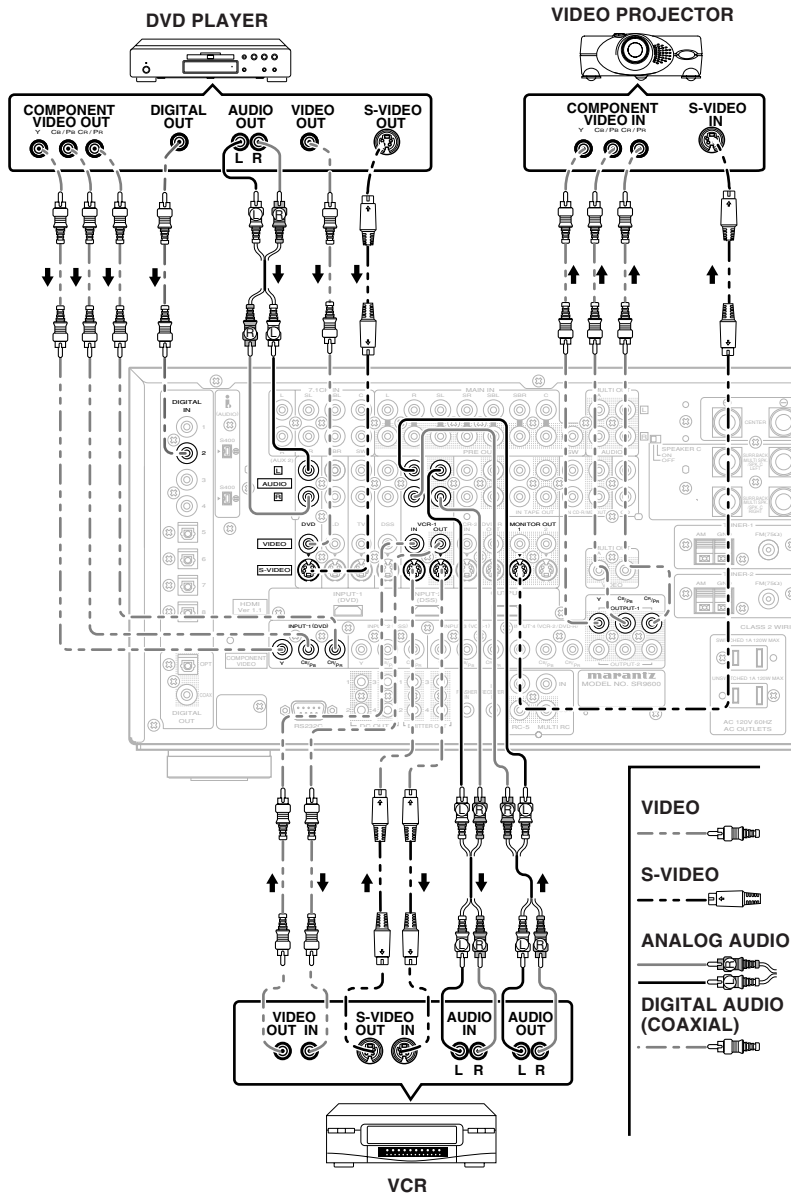

VIDEO, S-VIDEO, COMPONENT JACKS

There are 3 types of video jacks on the rear panel.

VIDEO jack

The video signal for the VIDEO jacks is the conventional composite video signal.

S-VIDEO jack

The video signal is separated into luminance (Y) and color (C) signals for the S-VIDEO jack. The S-VIDEO signals enable high-quality color reproduction. If your video component has an S-VIDEO output, we recommend to use it. Connect the S-VIDEO output jack on your video component to the S-VIDEO input jack on the SR9600.

COMPONENT jack

Make component video connections to a TV or monitor with component inputs to produce higher quality video images. Use a component video cable or 3 video cords to connect the COMPONENT VIDEO OUT jacks on the SR9600 to the monitor.

Notes:

- Be sure to connect the left and right audio channels properly. Red connectors are for the R (right) channel, and white connectors are for L (left) channel.
- Be sure to connect the inputs and outputs of the video signals properly.
- If you connect the S-VIDEO or component signal to the S-VIDEO or component jack on the SR9600, it is not necessary to connect the VIDEO (composite) jack. If you use both video inputs, the SR9600 gives priority to the S-VIDEO signal.
- Each type of video jack works independently. Signals input to the VIDEO (composite) and S-VIDEO jacks or COMPONENT VIDEO are output to the corresponding VIDEO (composite) and S-VIDEO or COMPONENT VIDEO jacks, respectively.
- The SR9600 has the VIDEO-AUTO ON/OFF function to turn the video equipment on or off automatically, by sensing the incoming video signal from the VIDEO jacks.
- You may need to setup the digital audio output format of your DVD player, or other digital source components. Refer to the instructions of the each component connected to the digital input jacks.
- There is no Dolby Digital RF input jack. Use an external RF demodulator Dolby Digital decoder when connecting the Dolby Digital RF output jack of the videodisc player to the digital input jack.
- The same video signal is output from the video monitor 1 and 2 jacks, therefore you may connect to either jack.
- The same video signal is output from the component output 1 and 2 jacks, therefore you may connect to either jack.

HDMI JACK

This unit has two HDMI inputs and one HDMI output. It can send digital video and audio signals from DVDs and other sources directly to a display. It minimizes signal degradation caused by analog conversion so that high quality images can be enjoyed. Select an input source from the OSD menu system. (See page 44)

Notes:

- When the HDMI output is connected to a display monitor that does not support HDCP, signals are not output. To view images in HDMI, it is necessary to connect to a display that supports HDCP.
- There may be no image output if connected to a TV or display that is not compatible with the above format.
- Refer to the instruction manual of the TV or display to be connected to the SR9600 for detailed information regarding the HDMI terminal.

* **HDCP: High-bandwidth Digital Content Protection**

CONNECTING HDMI DEVICES

An HDMI cable (sold separately) is used to connect the HDMI jack on the SR9600 with the HDMI jack on a DVD player, TV, projector or other component. To transmit multichannel audio via HDMI, the connected player must support multichannel audio transmission through its HDMI jack.

HDMI video streaming is compatible with DVI in principle. Therefore, it is possible to connect to a TV or monitor that has a DVI terminal using an HDMI-DVI conversion cable or plug. When connecting to a DVI terminal, connect the audio signal separately.

Notes:

- Some HDMI components can be controlled over the HDMI cable, but this receiver cannot control other components this way.
- When connected to a monitor (i.e., TV, projector, etc.) that does not support HDCP, video and audio are not output.
- DVI cables come with 24-pin and 29-pin plugs. This receiver supports 24-pin DVI-D cables; 29-pin DVI cables cannot connect to it.
- Some source devices such as DVD players do not support HDMI repeater operations like those of the SR9600. In such case, pictures are not properly projected on monitors such as TVs and projectors.
- When multiple components are connected to this receiver, turn power to unused components off to prevent interference between them.

- Disconnecting or connecting cables with the power on can damage the equipment. Turn the power off before disconnecting or connecting cables.
- Some DVD-Audio disks disable downmixing. These types of disks are not played back correctly unless the left, center, right and surround left and right speakers, and subwoofer are connected.
- If a DVD player that does not support HDMI 1.1 is connected to the SR9600, multi channel PCM playback is not possible even with DVD-Audio disks.
- If a DVD player or other device with DVI output is connected to the SR9600, a separate audio cable (i.Link, optical-digital, coaxial digital or analog) is needed for the audio signals. In this case, select the connected audio input as explained in “**1-1 FUNC INPUT SETUP**”. (See page 33)
- Multi channel PCM signals and audio signals of 62 kHz or higher that are input from the DIGITAL OUT jacks, are not output from the DIGITAL OUT jacks.
- Depending on the quality of the cable used, the HDMI signal may be affected by noise.

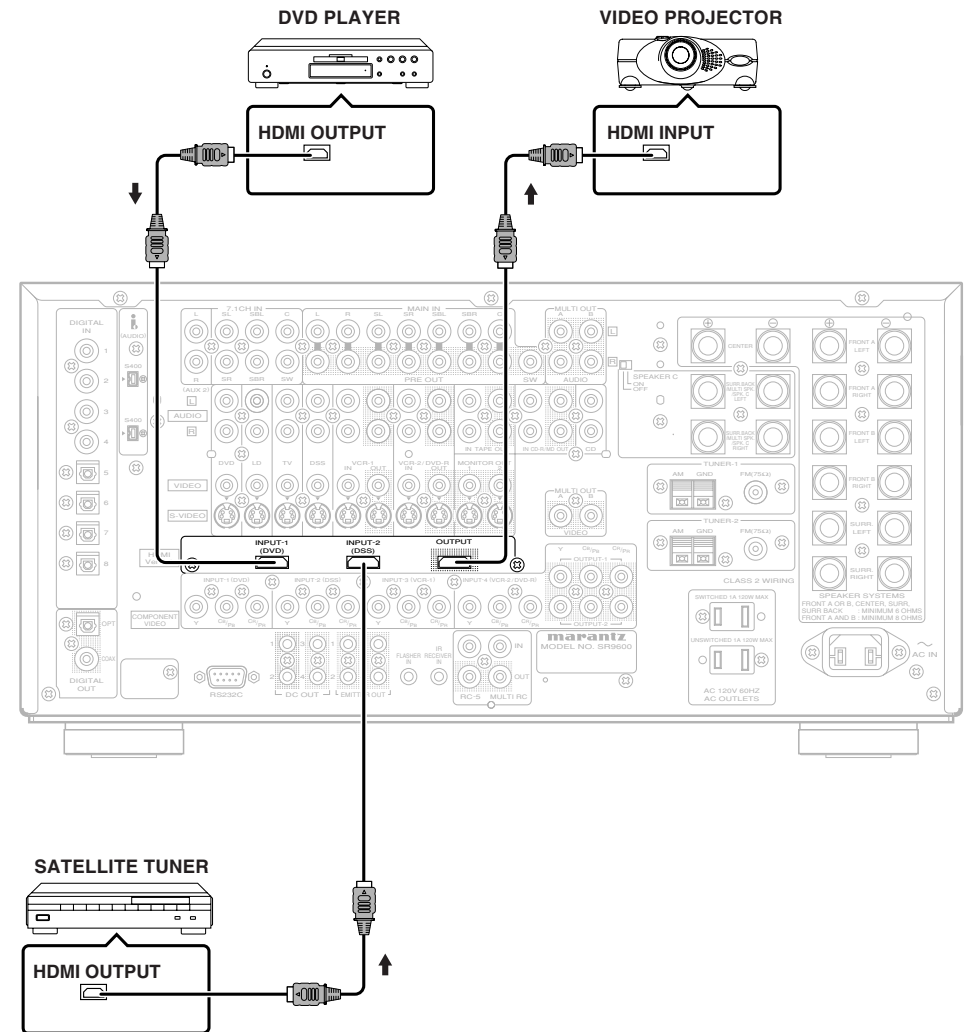

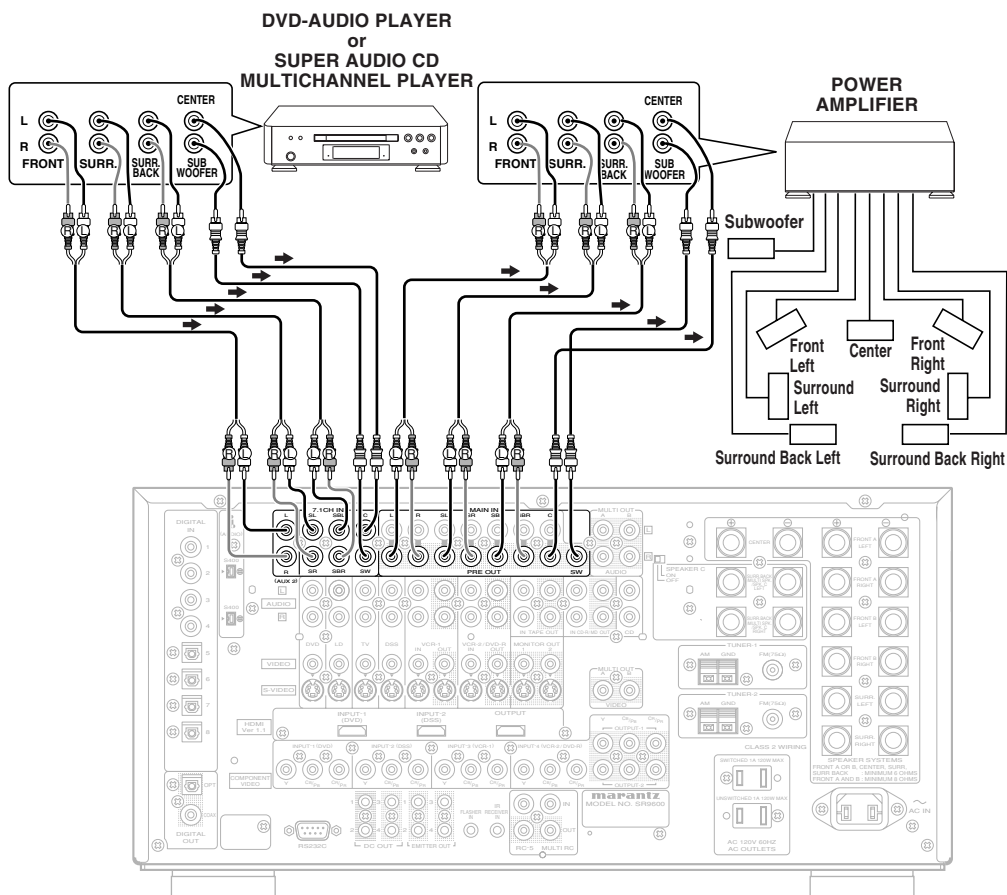

CONNECTING MULTICHANNEL AUDIO SOURCE

The 7.1ch input jacks are for multichannel audio source such as a Super Audio CD multichannel player, DVD-audio player or external decoder. If you use these jacks, switch on the 7.1ch input and set the 7.1ch input level from the OSD menu system. (see page 33).

CONNECTING AN EXTERNAL POWER AMPLIFIER

The PRE OUT jacks are for connecting external power amplifiers. Be sure to connect each speaker to the corresponding external power amplifier.

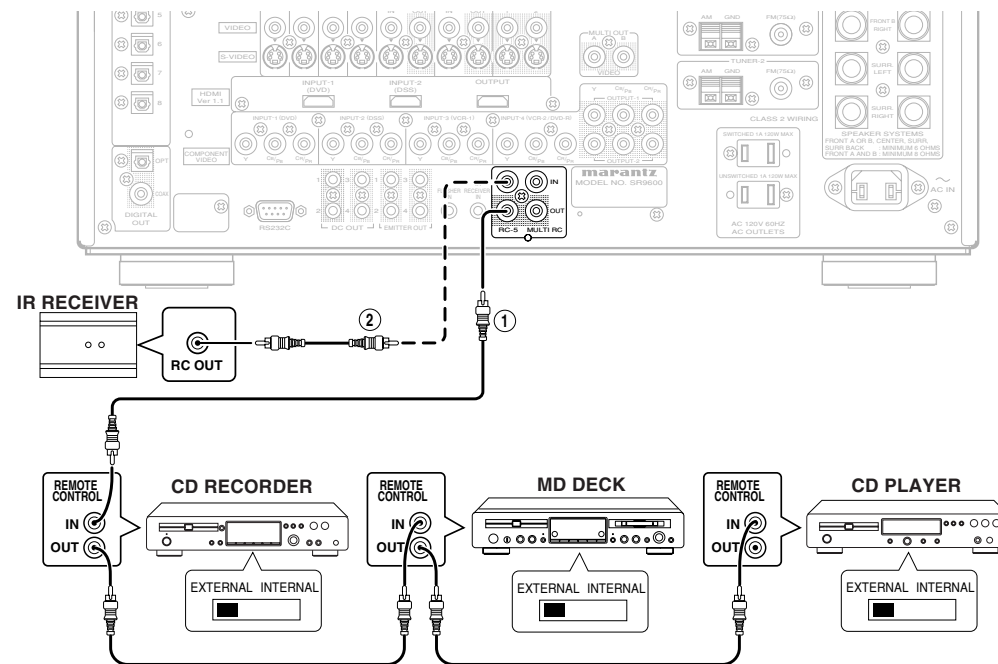

① You can control other Marantz products through the SR9600 with the remote control by connecting the REMOTE CONTROL terminals on each unit. The signal transmitted from the remote control is received by the remote sensor on the SR9600, then the signal is sent to the connected device through this terminal. Therefore you need to aim the remote control only at the SR9600. Also, if a Marantz power amplifier (some models excluded) is connected to one of these terminals, the power amplifier's power switch is synchronized with this unit's power switch.

Set the REMOTE CONTROL SWITCH on the other units, (not the SR9600) to "EXT."(external) to use this feature.

② Whenever external infrared sensors or similar devices are connected to the RC-5 IN jack on the SR9600, be sure to always disable operation of the infrared sensor on the SR9600 by using the following procedure.

1. Hold down the **MULTI** button and the **MENU** button on the front panel at the same time for five seconds.
2. The setting "IR=ENABLE" is shown on the FL display.
3. Press the **ENTER** buttons to change this to "IR=DISABLE".
4. Press the **OK/ENTER** button for five seconds. The infrared sensor on the main unit is now disabled.

Note:

- Be sure to set to "IR=ENABLE" when external infrared sensors or similar devices are not connected. Otherwise, the SR9600 will be unable to receive remote control commands.
- 5. To restore to the original setting, perform steps 1 to 4 and set to "IR=ENABLE".

CONNECTING THE ANTENNA TERMINALS

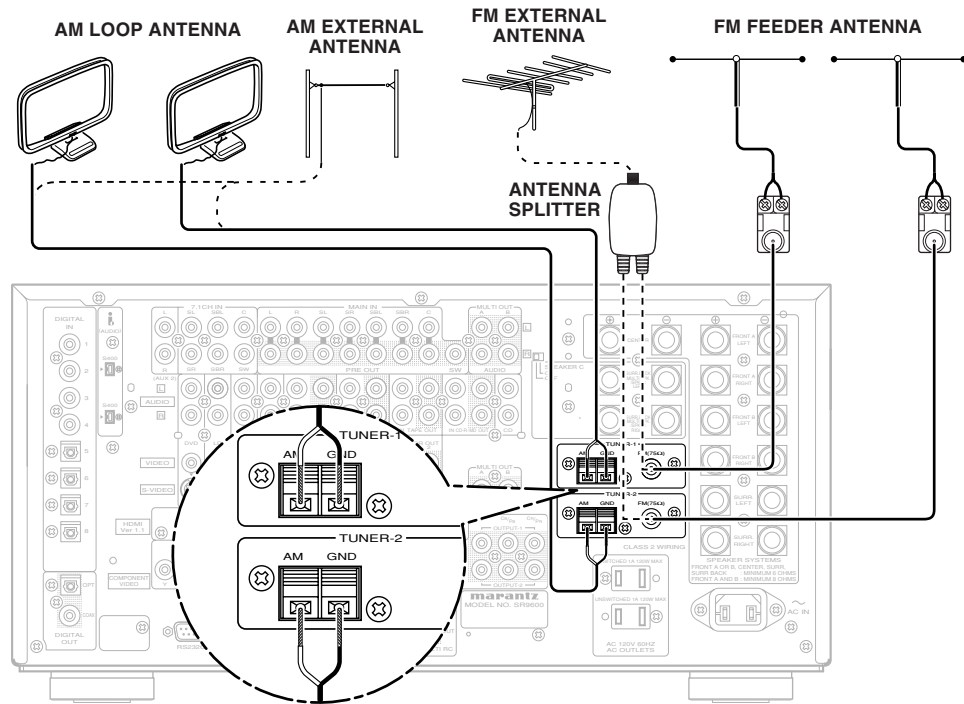

ASSEMBLING THE AM LOOP ANTENNA

1. Release the vinyl tie and take out the connection line.

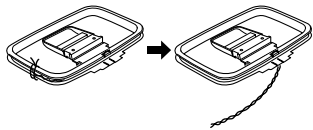

2. Bend the base part in the reverse direction.

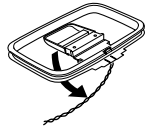

3. Insert the hook at the bottom of the loop part into the slot at the base part.

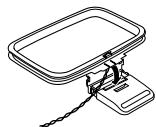

4. Place the antenna on a stable surface.

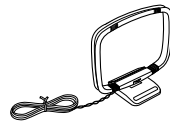

CONNECTING THE ANTENNA WIRE TO THE ANTENNA CONVERTER

Loosen the screws and attach the wire terminals, then tighten the screws with a screwdriver.

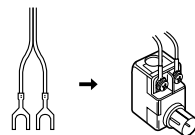

CONNECTING THE SUPPLIED ANTENNAS

Connecting the supplied FM antenna

The supplied FM antenna is for indoor use only. During use, extend the antenna and move it in various directions until the clearest signal is received.

Fix it with push pins or similar implements in the position that will cause the least amount of distortion.

If you experience poor reception quality, an outdoor antenna may improve the quality.

Connecting the supplied AM loop antenna

The supplied AM loop antenna is for indoor use only.

Set it in the direction and position it to where you receive the clearest sound. Put it as far away as possible from the unit, TVs, speaker cable, and power cord.

If you experience poor reception quality, an outdoor antenna may improve the quality.

1. Press and hold down the lever on the AM antenna terminal.
2. Insert the bare wire into the antenna terminal.
3. Release the lever.

Note:

- Connect the shielded grounding wire (black) to the AM antenna GND terminal.

CONNECTING AN FM OUTDOOR ANTENNA

Notes:

- Keep the antenna away from noise sources (neon signs, busy roads, etc.).
- Do not put the antenna close to power lines. Keep it well away from power lines, transformers, etc.
- To avoid the risk of lightning and electrical shock, grounding is necessary.

CONNECTING AN AM OUTDOOR ANTENNA

An outdoor antenna will be more effective if it is stretched horizontally above a window or outside.

Notes:

- Do not remove the AM loop antenna.
- To avoid the risk of lightning and electrical shock, grounding is necessary.

CONNECTING FOR MULTIROOM LISTENING

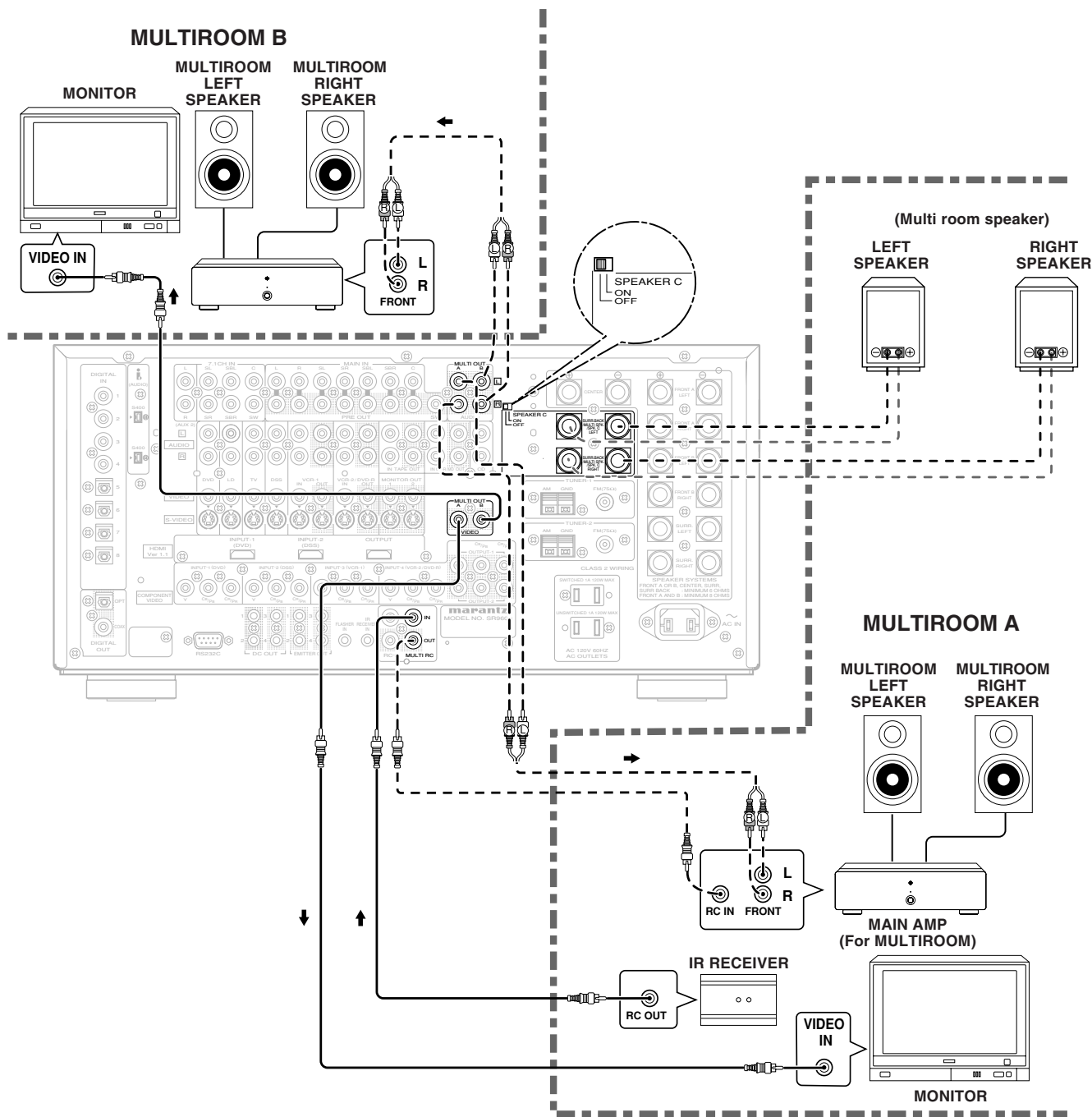

CONNECTING FOR SPEAKER C USE

Bi-amp connection

A bi-amp connection is possible with speakers that have two sets of inputs (for treble and bass). This allows you to drive the treble and bass units with separate channel amps, which enables better sound quality. Connect the speakers as shown in the figure. Set the SPEAKER C switch on the rear panel to ON.

Notes:

- If incorrectly connected, a protective circuit in the receiver will trip and set the receiver to standby. (The STANDBY indicator will flash.) If this occur, recheck the connections between the speakers and the receiver.
- Turn the receiver power off before changing the setting of the SPEAKER C switch.
- If the speaker is fitted with a shorting bar, remove the shorting bar.

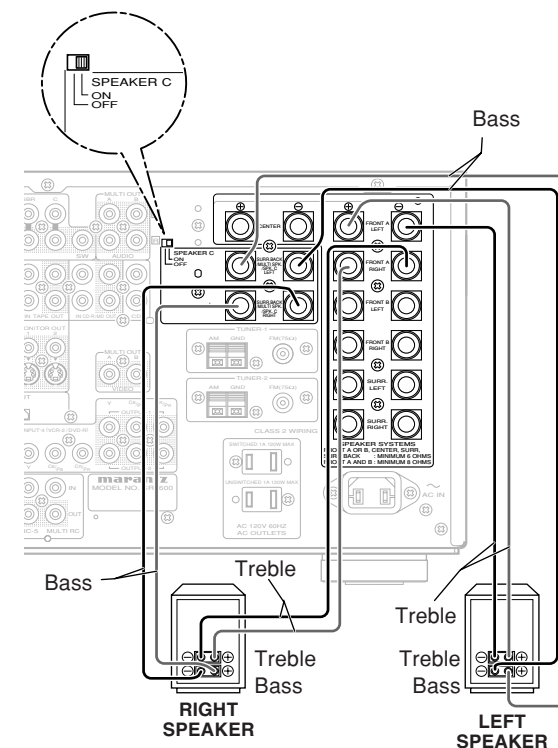

Note:

- You can use surround back speaker terminals as MULTI SPK. terminals or SPEAKER C terminal when you are not using surround back speakers.

CONNECTING i.LINK COMPONENTS

The SR9600 connects to i.LINK components that support up to S400 (400 Mbps). Use a 4-pin i.LINK cable that supports S400 for i.LINK connections with this receiver.

Video data cannot be transmitted via the i.LINK (Audio) supported by this receiver. To connect to a video component, connect the video signal separately. When connected to other Marantz products using i.LINK, the system can be operated over the i.LINK cable.

When multiple i.LINK components are connected to the receiver, data can be transmitted through the other i.LINK components. The components do not have to be connected in a specific order to do this. (see page 34)

i.LINK does not distinguish between input and output terminals in two-way communications. Input and output are switched according to the direction in which signals flow.

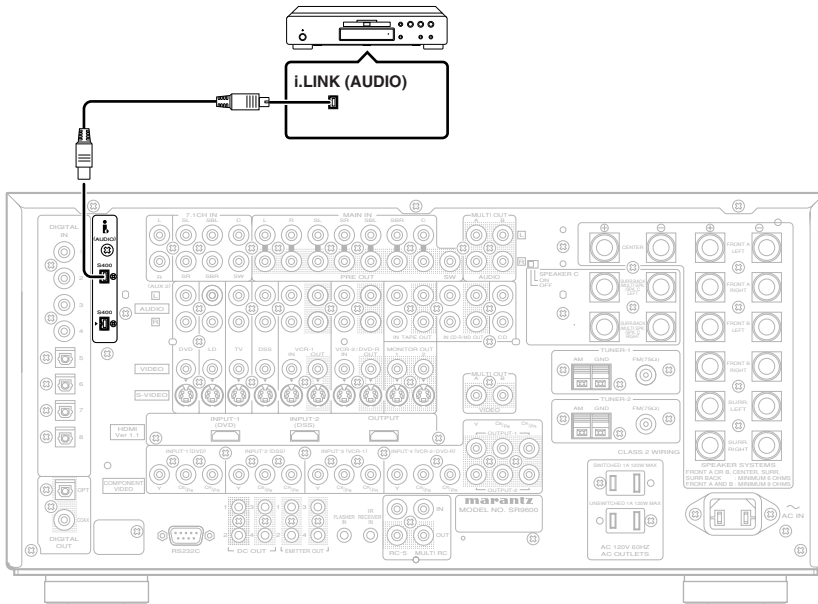

Example connection :

Up to 17 devices can be connected in a daisy chain.

The SR9600 can detect up to 15 components.



Example connection :

Up to 63 devices can be connected in a tree formation by branching. This kind of connection is possible with devices that have 3 or more i.LINK connectors.

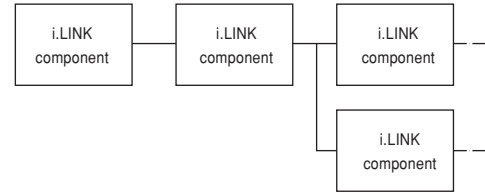

Bad connection example:

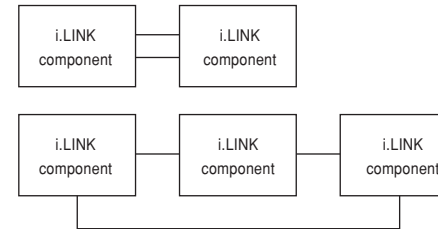

Do not connect devices in a loop as shown in the figure.

Notes:

- The i.LINK feature of the SR9600 supports only devices (digital broadcast receiver (MPEG-2 TS), digital video (DV), etc.) that support i.LINK (Audio). Do not connect unsupported devices because malfunctions can occur.
- During playback of an i.LINK device, do not disconnect or connect the i.LINK cable of other devices. Also, do not connect new devices or turn the power on/off. This can cut off the sound.
- Some i.LINK devices cannot relay data while power is off or the device is on standby. See the instruction manual of the connected device. The SR9600 does not relay data in this state either.
- The maximum data transfer speed of an i.LINK device is labeled near to its i.LINK connector. This maximum data speed is standardized as S100 (100 Mbps), S200 (200 Mbps) and S400 (400 Mbps). The SR9600 has a maximum data transfer speed of S400, but if the connected device supports only S100 or S200, the actual data transfer may be slower than 400 Mbps.

Mbps stands for “mega bits per second”. It expresses the quantity of data that can be sent in 1 second. The SR9600 supports S400, therefore it sends 400 Mb of data every second.

- The i.LINK feature does not assure the connection and operation of all i.LINK devices. Whether data and control signals can be exchanged between i.LINK devices or not will depend on the functions of each device.
- Carefully check the configuration of the i.LINK connector before connecting an i.LINK cable. Forcing the cable into the connector in the wrong orientation can damage the connector.
- Do not connect an i.LINK cable with power to the SR9600 on.
- Use an i.LINK cable that is no longer than 3.5 m and that supports S400.
- Some players require i.LINK setup. For details, see the instruction manual of the device.
- * Some devices may require you to make settings with the device connected to the SR9600 during the setup.
- Audio signals input from the i.LINK connector are not output from the DIGITAL OUT jacks.
- With some source devices, it takes time before sound is produced. This time is needed to detect the status of both the device and the SR9600. The amount of time will differ according to the connected player.

Once the devices have been connected, activate power to the SR9600 and components, and make the settings as explained in “i.LINK SETUP” (see page 34). The i.LINK feature works as a temporary input source unless the settings are made. (See page 48)

ERROR MESSAGES FOR CONNECTED i.LINK DEVICES

“LOOP CONNECT”

This message is displayed if the i.LINK device is connected in a loop. Connect the device so that the connection does not form a loop.

“NODE OVER”

This message is displayed if more than 63 i.LINK devices are connected to the SR9600, including the SR9600. Limit connections to 63 a maximum devices including the SR9600.

“HOP OVER”

This message is displayed if more than 17 i.LINK devices are connected in a daisy chain. Keep daisy chain connections to a maximum 17 devices.

“BUS FULL”

This message is displayed if too many devices are outputting signals on the i.LINK bus. Either shut off power or disconnect unused devices.

“CANNOT LINK”

This message is displayed if the SR9600 cannot connect to an i.LINK device or if an unconnected device is selected as the input source. Disconnect and reconnect the i.LINK cable, or shut power to the SR9600 off and turn it back on.

MESSAGES WHEN AN i.LINK DEVICE IS CONNECTED

“LINK CHECK”

This message is displayed while the SR9600 checks for changes in i.LINK device connections.

“NO SIGNAL”

This message is displayed if a signal not supported by the SR9600 is input.

CONNECTING OTHER EQUIPMENT

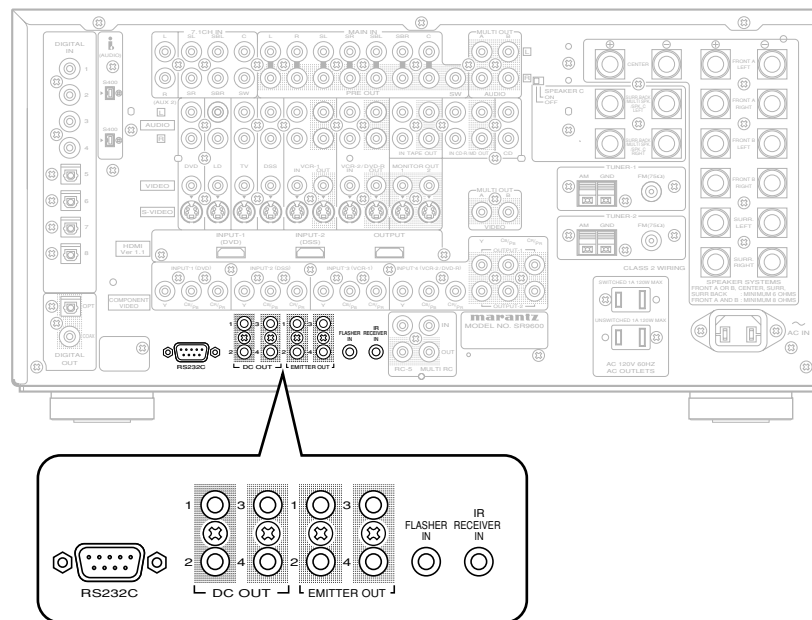

RS232C

Connect an external control device or other device for servicing. (Use a straight cable for the connection.)

DC OUT (DC TRIGGER)

External devices can be controlled from the SR9600 by connecting them to the DC OUT terminal (12 V).

EMITTER OUT

Outputs the remote control signal input to the IR RECEIVER IN terminals. External components can be controlled by connecting them to the EMITTER OUT terminal.

FLASHER IN

This receiver can be controlled by connecting a control box or other control device to this receiver.

IR RECEIVER IN

This receiver can be operated by remote control without using the internal IR receiver, by connecting an external IR receiver.

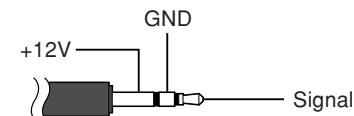

An IR receiver is connected as shown above.

Caution:

Wrongly connecting an IR receiver or connecting an IR receiver of the wrong voltage can damage the SR9600, therefore do not do this.

SETUP

After all components are connected, initial setup must be performed.

ONSCREEN DISPLAY MENU SYSTEM

The SR9600 incorporates an onscreen menu system, which makes various operations possible by using the cursor (▲, ▼, ◀, ▶) and **OK/ENTER** buttons on the remote control unit or on the front panel.

Note:

- To view the onscreen displays, make certain you have connected the **MONITOR OUT** jack on the rear panel to the composite, S-Video or component video input of your TV or projector. (See page 23)

1. Tap the **A/V Amp** on the remote control unit. (This step is not needed when operating the setup menus from the SR9600.)
2. Press the **M** button on the remote control or press the **MENU** button on the front panel. The **"MAIN MENU"** of the OSD menu system is displayed. There are 7 items in the MAIN MENU.
3. Select the desired sub-menu with the ▲ or ▼ cursor buttons and press the **OK/ENTER** button. The display will change to the selected sub-menu.

Notes:

- If you desire to adjust any sub-menu, you need to set it to **UNLOCKED**.
- To lock sub-menus, set items 1-7 on the MAIN MENU to **"LOCKED"**.

<Example>

- (1) With **"1. INPUT SETUP"** selected, press the ▶ cursor button to select **"UNLOCK"**.
 - (2) Select **"LOCKED"** with the ▲ or ▼ cursor buttons.
 - (3) Press the ◀ cursor button to enter the setting. A "●" will appear to the right of **"LOCKED"**.
 - (4) **"7. AUDIO STATUS"** cannot be set to **"LOCKED"**.
4. To exit from OSD menu system, press the **EXIT** button, or move the cursor to **EXIT** and press the **OK/ENTER** button.

Note:

- Settings are entered with the **ENTER** button on the unit or the **OK** button on the remote control unit. When using the remote control unit, use the **OK** button as if it were the **ENTER** button.

RC3200B BUTTON CONTROL

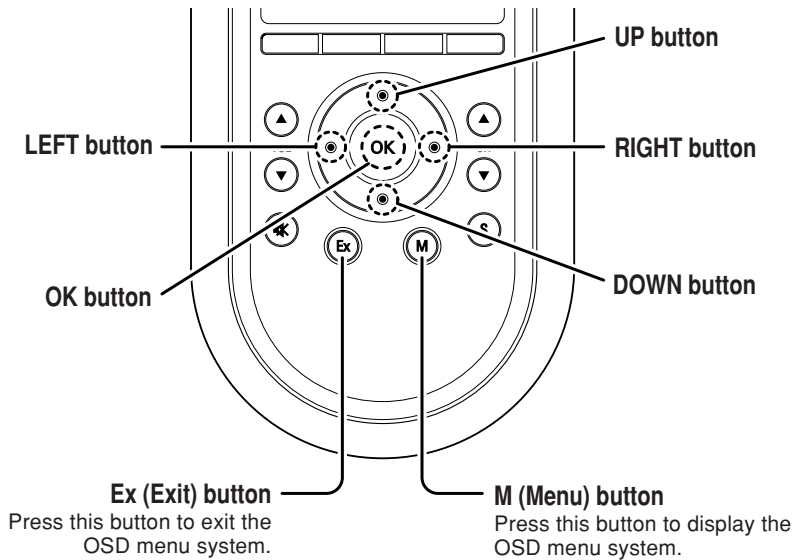

SR9600 FRONT BUTTON CONTROL

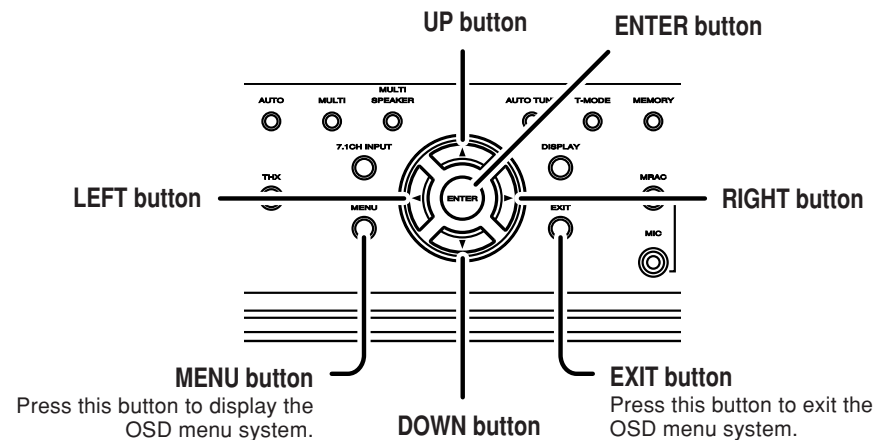

Note:

- After you complete this portion of the setup, move cursor to "RETURN" with the ▲, ▼, ◀ and ▶ cursor buttons and press the OK/ENTER button.

MAIN MENU

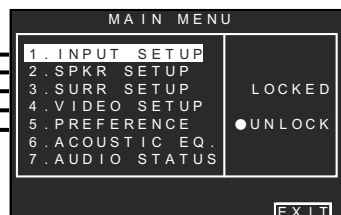

SUB MENU

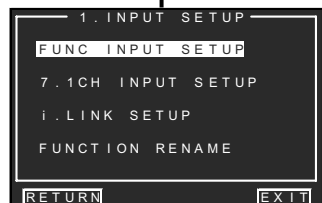

See "1. INPUT SETUP" (p.32)

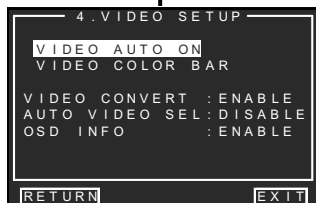

See "4. VIDEO SETUP" (p.43)

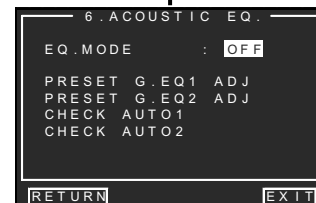

See "6. ACOUSTIC EQ" (p.46)

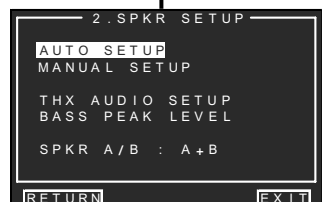

See "2. SPKR SETUP" (p.35)

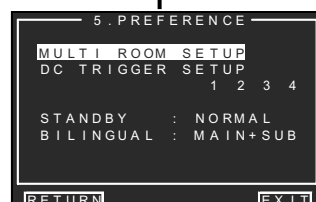

See "5. PREFERENCE" (p.44)

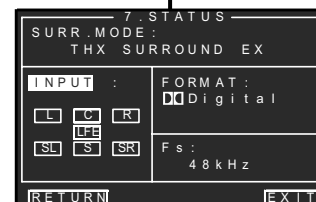

See "7. AUDIO STATUS" (p.47)

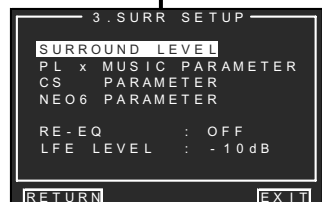

See "3. SURR SETUP" (p.41)

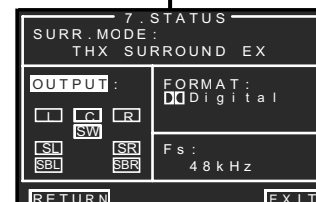

1 INPUT SETUP

This menu is for setting the matching the output of connected audio devices and the input jacks of this receiver.

- **FUNC INPUT SETUP :**
“1-1 FUNC INPUT SETUP” (see page 33)
- **7.1 CH INPUT SETUP :**
“1-2 7.1 CH INPUT SETUP” (see page 33)
- **i.LINK SETUP :**
“1-3 i.LINK SETUP” (see page 34)
- **FUNC RENAME :**
“1-4 FUNCTION RENAME” (see page 34)

1. Select “1. INPUT SETUP” from the MAIN MENU with ▲ or ▼ cursor button, and press the OK/ENTER button.

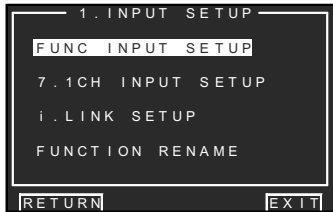

2. Select the desired sub-menu with the ▲ or ▼ cursor buttons, and press the OK/ENTER button.

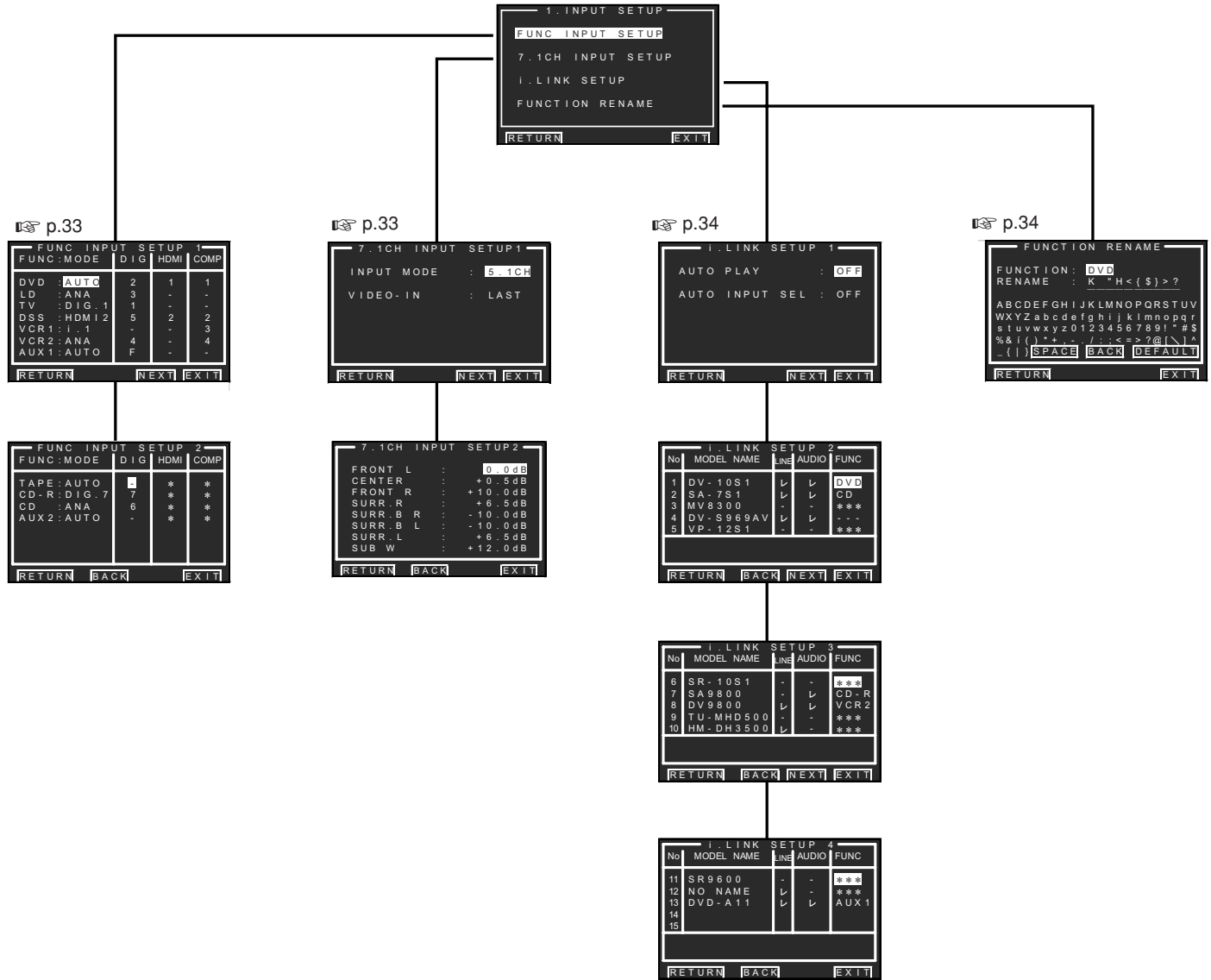

1-1 FUNC INPUT SETUP (ASSIGNABLE DIGITAL INPUT)

The 8 and F (Front) digital inputs can be assigned to a desired source.

HDMI and COMPONENT inputs can be assigned to the preferred source.

Use this menu to select which digital input jacks are to be assigned to which input source.

1. Select "**FUNC INPUT SETUP**" from the 1.INPUT SETUP menu with the ▲ or ▼ cursor buttons and press the **OK/ENTER** button.

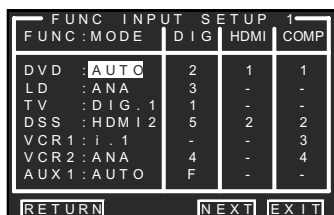

2. Select a setting with the ▲, ▼, ◀, and ▶ cursor buttons, and assign a mode and input jack (DIG, HDMI, COMP).

MODE

AUTO:

Select "**AUTO**", for automatic detection of the digital input signal condition.

If there is no digital signal, but there is an analog signal present, the analog signal will be played. "AUTO" is the initial setting of all input sources.

DIG. X:

Select "**DIG. X**", when only a digital signal will be used.

ANA:

Select "**ANA**" for input sources for which no digital input jacks are used.

HDMI:

Select "**HDMI1**" or "**HDMI2**".

i.LINK:

Select a number that can be set to i.LINK. "i.LINK" appears only when an i.LINK device has been assigned as an input source as explained in "i.LINK SETUP". (See page 34)

DIG

8 and F(Front) digital inputs can be assigned to a desired source.

Assign the number of a digital input jack to the device.

HDMI

Assign the number of an HDMI input jack to the device.

COMP

Assign the number of a component video input jack to the device.

3. Press the **OK/ENTER** button.
4. Select each mode setting and input terminal with the ◀ or ▶ cursor buttons.
5. Press the **OK/ENTER** button.
6. Repeat steps 2-5 until all items are set.
7. After you complete this portion of the setup, move the cursor to "**NEXT**" with the ▲, ▼, ◀ and ▶ cursor buttons and then press the **OK/ENTER** button to go to the next page.



8. Repeat steps 2-5 until all items are set. After you complete this portion of the setup, move the cursor to "**RETURN**" with ▲, ▼, ◀ and ▶ cursor buttons and press the **OK/ENTER** button.

To return to the Func Input Setup 1 menu from the Func Input Setup 2 menu, move the cursor to "**BACK**" with the ▲, ▼, ◀ and ▶ cursor buttons and press the **OK/ENTER** button.

1-2 7.1 CH INPUT SETUP

This menu is for adjusting the speaker levels for 7.1-channel input sources.

Here you will adjust the volume for each channel so that they are all heard by the listener at the same level.

1. Select "**7.1 CH INPUT SETUP**" from the 1.INPUT SETUP menu with the ▲ or ▼ cursor buttons and press the **OK/ENTER** button.

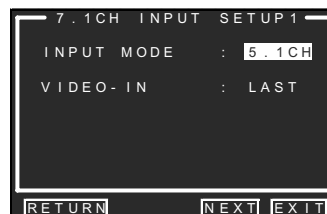

2. Select "**INPUT MODE**" with the ▲ or ▼ cursor buttons.
3. Select "**7.1 CH**" or "**5.1 CH**" with the ◀ and ▶ cursor buttons.
4. Select "**VIDEO IN**" with the ▲ or ▼ cursor buttons.
5. Using the ◀ or ▶ cursor buttons, select the video input source to be played through the MONITOR OUT jack. The input source is switched by pressing the ◀ or ▶ cursor buttons as follows:
LAST ↔ **DVD** ↔ **LD** ↔ **TV** ↔ **DSS** ↔ **VCR1** ↔ **VCR2** ↔ **AUX1** ↔ **V-OFF** ↔ **LAST** ↔...

Notes:

- When "**LAST**" is selected, the source is set to the source selected before the 7.1 ch input menu was activated.
- When "**V-OFF**" is selected, no signal is emitted from MONITOR OUT jack.

6. After you complete this portion of the setup, move the cursor to "**NEXT**" with the ▲, ▼, ◀ and ▶ cursor buttons and press the **OK/ENTER** button to go to the next page.

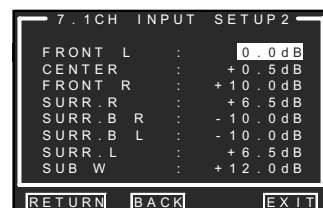

7. Select desired channel with the ▲ or ▼ cursor buttons.
8. Using the ◀ or ▶ cursor buttons, adjust the volume level of each channel.

Move the cursor to "**RETURN**" with the ▲, ▼, ◀ and ▶ cursor buttons, and press the **OK/ENTER** button to go to the 1.INPUT SETUP menu.

To return to the 7.1 Ch Input Setup 1 menu from the 7.1 Ch Input Setup 2 menu, move the cursor to "**BACK**" with the ▲, ▼, ◀ and ▶ cursor buttons and press the **OK/ENTER** button.

Note:

- The volume level can be set between -12 dB and +12 dB in 0.5 dB increments on all channels except the subwoofer (SUB W), which can be set from -18 dB to +12 dB in 0.5 dB increments.

1-3 i.LINK SETUP

This menu sets communication between i.LINK-connected components and the SR9600.

1. Select "i.LINK SETUP" from the 1.INPUT SETUP menu with the ▲ or ▼ cursor buttons and press the **OK/ENTER** button.

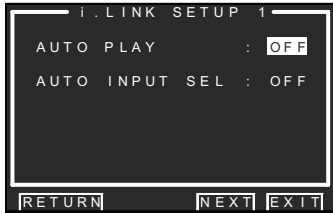

2. Select "AUTO PLAY" with the ▲ or ▼ cursor button.

3. Select "ON" or "OFF" with the ◀ or ▶ cursor buttons.

AUTO PLAY:

Select whether or not to automatically play an i.LINK component when it is selected by this receiver.

ON:

The play command is sent to the i.LINK component. (With some i.LINK components, it is necessary to set auto play on the component itself.)

OFF:

Play is manually controlled.

4. To select "AUTO INPUT SEL", press ▲ or ▼ cursor button.

5. Select "ON" or "OFF" with the ◀ or ▶ cursor buttons.

AUTO INPUT SEL:

Select whether to automatically set the SR9600 to the i.Link component when the component is set to play from the component itself.

ON:

The i.LINK component is selected when play operation is detected on the component. (With some i.LINK components, it is necessary to set auto play on the component itself.)

OFF:

The SR9600 does not select the i.LINK component. (With some i.LINK components, it is necessary to set the component for auto i.LINK control on the component itself.)

6. After you complete this portion of the setup, move the cursor to "NEXT" with the ▲ or ▼ cursor buttons and press the **OK/ENTER** button to go to the next page.

i.LINK SETUP 2			
No	MODEL NAME	LINE AUDIO	FUNC
1	DV - 10S1	レ	DVD
2	SA - 7S1	レ	CD
3	MV8300	-	***
4	DV - S969AV	レ	- - -
5	VP - 12S1	-	***

Navigation buttons: RETURN, BACK, NEXT, EXIT

This menu is for viewing the connected status of i.LINK components and assigning i.LINK component information to each one. i.LINK components are registered from No. 1 to No. 15 in the order in which they are detected by this receiver.

• MODEL NAME

The model name of the i.LINK component is automatically acquired from the component. (When a model name cannot be acquired, "NO NAME" is displayed.) Model names longer than 9 characters are cut off after the ninth character.

• LINE

Displays the connected status of the i.LINK component in real-time.

- ✓ Connected
- Disconnected

(Or power to the device is not on.)

• AUDIO

Displays the audio support of i.LINK components.

- ✓ Audio supported
- The component does not support i.LINK audio or not a source component.

• FUNC

When "----" is displayed, the component can be assigned as an input source.

When "***" is displayed, the device cannot be assigned as an input source.

7. Select the input MODEL NAME, press the ▲ or ▼ cursor buttons.

8. Assign an input source with the ◀ or ▶ cursor buttons.

9. When 6 or more i.LINK devices are registered with this receiver, after you complete this portion of the setup, move the cursor to "NEXT" with the ▲, ▼, ◀ and ▶ cursor buttons and press the **OK/ENTER** button to go to the next page.

10. Make settings on the i.LINK SETUP 3 and 4 menus in the same way.

To return to the i.LINK Setup 1 menu from the i.LINK Setup 2 menu, move the cursor to "BACK" with the ▲, ▼, ◀ and ▶ cursor buttons and press the **OK/ENTER** button.

REMOVING REGISTERED i.LINK COMPONENTS:

A registered i.LINK component can be removed from the registered components list if "-" appears under LINE.

Move the cursor to the FUNC item of the component indicated by "-" under LINE with the ▲ or ▼ cursor buttons, and press the **OK/ENTER** button.

The message "DELETE? YES NO" appears. Select "YES" with the ◀ or ▶ cursor buttons and press the **OK/ENTER** button. This cancels registration and removes the component from the list. After a component has been removed from the list, other registered components move up to fill its spot.

Note:

- Linkage to and operation of all i.LINK devices are not guaranteed. Not all components may work over the i.LINK interface. Operation has only been verified between Marantz components.

1-4 FUNCTION RENAME

Input sources can be registered under any name. This menu is for renaming input source.

This menu is for renaming function name. Names can be up to 10 characters long, including spaces. (Characters are selected from those appearing on the display.) This name appears on the receiver's FL display and the OSD, but it does not appear in the OSD Setup menu.

1. Select "FUNCTION RENAME" from the 1. INPUT SETUP menu with the ▲ or ▼ cursor buttons and press the **OK/ENTER** button.

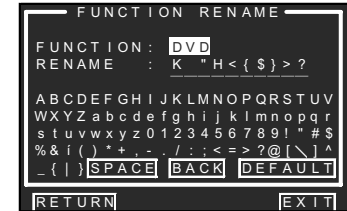

2. Select "FUNCTION" with the ▲ or ▼ cursor buttons.

3. Select an input source with the ◀ or ▶ cursor buttons.

4. Select "RENAME" with the ▲ or ▼ cursor buttons.

5. Move the cursor to the character (1st to 10th) to change with the ◀ or ▶ cursor buttons.

6. Move the cursor to the character list with the ▼ cursor button. (Move the cursor to the letter "A" to begin with.)

7. Select a character with the ▲, ▼, ◀ and ▶ cursor buttons.

8. Press the **OK/ENTER** button to enter the selected letter.

9. Repeat steps 5-8 until the new name is input.

BACK:

Deletes the character left of the cursor in the "RENAME" area one character at a time.

DEFAULT:

Restores the name in the "RENAME" area to the name in the "FUNCTION" area.

SPACE:

Inserts a space at the cursor point of the "RENAME" area.

Move the cursor to "RETURN" with the ▲, ▼, ◀ and ▶ cursor buttons and press the **OK/ENTER** button to go to the 1. INPUT SETUP menu.

2 SPKR (SPEAKER) SETUP

After you have installed the SR9600, connected all the components and determined the speaker layout, it is now time to perform the settings in the Speaker Setup menu for the optimum sound acoustics for your environment and speaker layout.

Before you perform the following settings, it is important that you first determine the following characteristics:

- **AUTO SETUP:**
"2-1 MRAC" (see page 36)
- **MANUAL SETUP:**
"2-2 MANUAL SETUP" (see page 37)
- **THX AUDIO SETUP:**
"2-3 THX AUDIO SETUP" (see page 39)
- **BASS PEAK LEVEL:**
"2-4 BASS PEAK LEVEL" (see page 40)

Note:

- These settings cannot be selected when "THX ULTRA2 SUB-W" has been set to "YES" in the THX AUDIO SETUP menu.

1. Select "2.SPKR SETUP" from the MAIN MENU with **▲** or **▼** cursor buttons and press the **OK/ENTER** button.

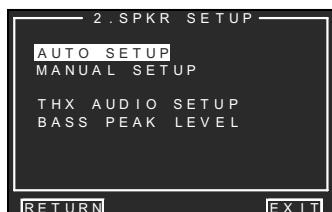

2. Select the desired menu with the **▲** or **▼** cursor buttons, and press the **OK/ENTER** button.

Note:

- After you complete this the portion of the setup, press the **OK/ENTER** button. The cursor will move to "RETURN" and press the **OK/ENTER** button to go to the Sub-menu.

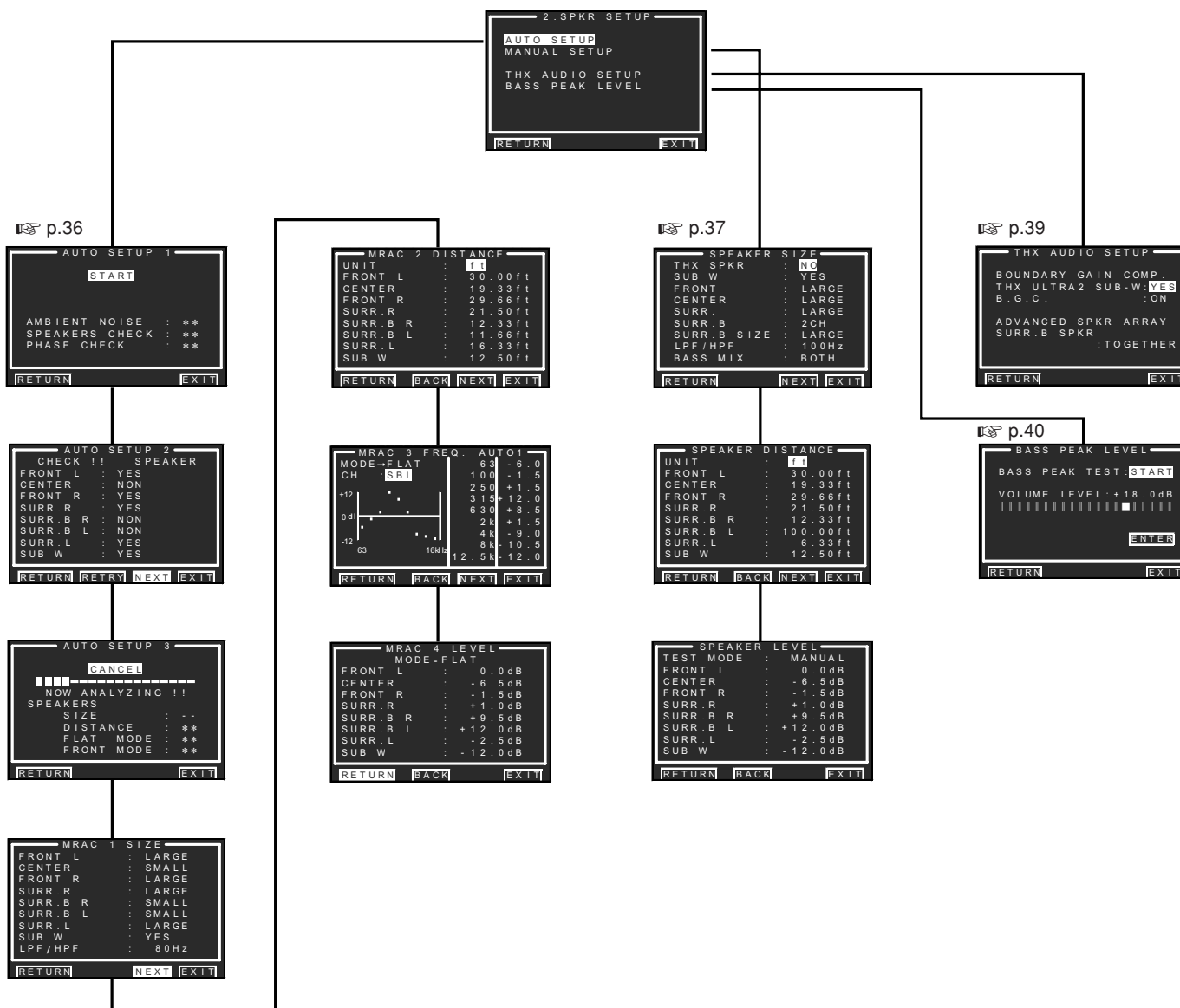

2-1 MRAC (Marantz Room Acoustic Calibration)

Speaker settings that would be difficult to configure using manual setup can now be performed by automatically measuring speaker characteristics using the microphone.

Measurement

During measurement, a test tone is output from the speakers, which is then measured and analyzed through the microphone. The item and the order in which they are measured are as follows:

AUTO SETUP 1

AMBIENT NOISE: Ambient noise measurement

SPEAKER CHECK: Speaker connected/not connected check

PHASE CHECK: Speakers phase check

AUTO SETUP 2

Results from the measurements are checked.

AUTO SETUP 3

SPEAKER SIZE: Speaker characteristics check

SPEAKER DISTANCE: Distance from speaker (delay time) check

FLAT MODE: Speaker frequency measurement. This measurement identifies the frequency required to compensate the sound to the flat level.

FRONT MODE: Speaker frequency measurement. This measurement identifies the frequency required to match the front speaker characteristics.

How to operate

Since settings are displayed on the monitor during setup, turn the monitor on.

1. Connect the included microphone to the MIC jack on the SR9600.

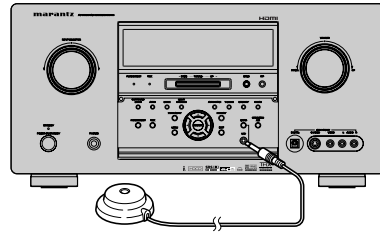

2. Set the microphone at ear height in the actual listening position. Use a stand or tripod to position the microphone.

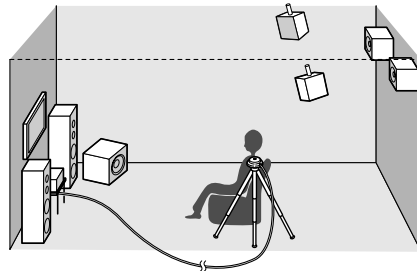

Notes:

- Remove any obstructions between the speakers and the microphone.
- Keep the room quiet during measurement.
- The test tone emitted during measurement is loud. Please be considerate of neighboring homes and children.
- If using a powered subwoofer, set volume to medium level and the crossover frequency to the highest level.
- Step away from the listening position during measurement and operate the SR9600 with the remote control unit from outside the speaker path.
- The MRAC feature is not available in the following modes.
 - 7.1 Ch Input
 - Pure Direct
 - Source Direct
 - Dolby Headphone

3. Either press the **MRAC** button on the front panel of the SR9600, or select **"2. SPKR SETUP"** on the MAIN MENU. Select **"AUTO SETUP"** with the **▲** or **▼** cursor buttons and press the **OK/ENTER** button.
4. Select **START** on the **AUTO SETUP 1** display and press the **OK/ENTER** button to start measurements.

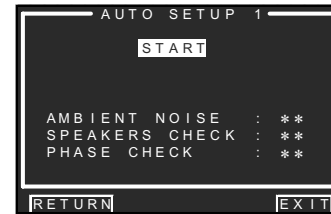

Measurement in progress examples

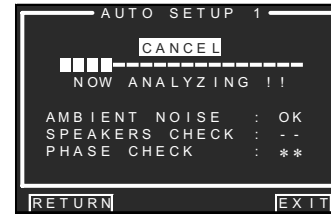

START:

Press the **OK/ENTER** button. The indication changes to **"CANCEL"** and processing starts.

CANCEL (Available only during processing):

Interrupt processing with the **OK/ENTER** button. The status prior to the start of Auto Setup 1 is restored.

Progress bar:

Restarts from 0 each time processing ends for each item. During measurement, **"--"** appears in the message area, otherwise **"**"** appears. When measurement ends successfully, **"OK"** is displayed.

5. Measurement results are displayed. Check the speaker system.
 - YES:** Speakers connected
 - NON:** Speakers disconnected
 - REV:** The speaker cable is opposite in polarity (Check the speaker's cable connection.)
 - ERR:** The speaker layout is incorrect. (Check against cable connection diagrams.)

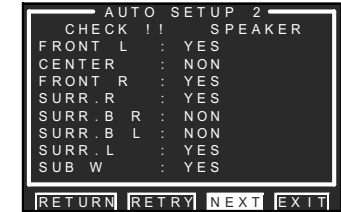

Error example

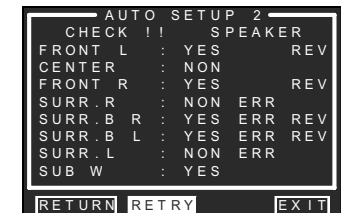

Move the cursor to **"NEXT"** or **"RETRY"** with the **◀** or **▶** cursor buttons and press the **OK/ENTER** button.

RETRY: Retries measurement from the beginning.
NEXT: Advances to the Auto Setup 3 menu. (If there is an error, **"NEXT"** cannot be displayed.)

6. Move the cursor to **"NEXT"** with the **▲**, **▼**, **◀** and **▶** cursor buttons and press the **OK/ENTER** button. Measurement starts for the remaining items.
7. When measurements are complete, **"FINISH!!"** and **"CHECK RESULT"** are displayed.

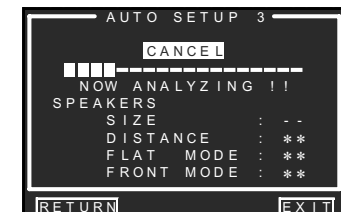



Notes:

- The measured speaker distance may differ from the actual distance from speakers. Nevertheless, the measured value is suitable for the speakers.
- The included microphone is designed specifically for the SR9600. Other microphones do not guarantee suitable measurement results. Use the included microphone to conduct measurements.
- During measurement, press the **OK/ENTER** or **EXIT** button to cancel measurement.
- In some rooms, an error may occur during auto speaker setup or it may not be possible to set speaker distance correctly because of room acoustics. In such case, set the speaker distance using “**MANUAL SETUP**”.
- If the **SPEAKER C** selector switch (rear panel) is set to “**ON**”, the surround back speakers do not output audio.

Error indications during measurement

If trouble occurs during measurement, an error message is displayed on the monitor screen and FL display. Those errors and their remedies are described below.

MIC SETUP ERROR
The microphone (MC-10) is not properly connected. → Check the microphone connection.
TOO MUCH NOISE
Measurement cannot be done correctly because of excessive ambient noise. → Either temporarily turn off power to noisy devices such as air conditioning or move them out of the room. → Retry measurement when the room is quiet.

8. Once finished, disconnect the microphone from the SR9600.
9. When “**CHECK RESULT**” appears on the FL display, press the **OK/ENTER** button. The MRAC 1 Size menu displays measurement results indicating which speakers are connected and their sizes.

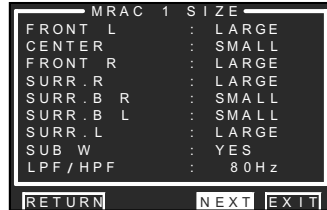

10. Move the cursor to “**NEXT**” with the ◀ or ▶ cursor buttons and press the **OK/ENTER** button. The distance from the microphone to each of the speaker is displayed.

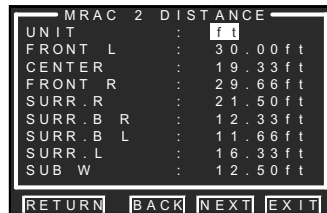

11. Select either **m** (meters) or **ft** (feet) for UNIT with the ◀ or ▶ cursor buttons.
12. Move the cursor to “**NEXT**” with the ▲ or ▼ cursor buttons and then press the **OK/ENTER** button. The frequency is automatically compensated for to the flat level of the all channel and is indicated in dB by channel. (EQ mode: AUTO 1) This compensation level is indicated somewhere between -12 dB and +12 dB in 0.5 dB increments.

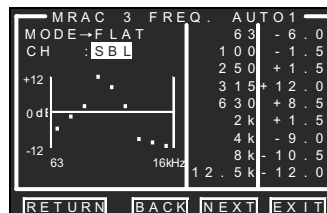

13. Select “**CH**” with the ◀ or ▶ cursor buttons.

14. Move the cursor to “**NEXT**” with the ▲, ▼, ◀, and ▶ cursor buttons and press the **OK/ENTER** button.

The frequency is automatically approximated based on the front speaker characteristics and is indicated in dB by channel. (EQ mode: AUTO 2)

This compensation level is indicated somewhere between -12 dB and +12 dB in 0.5 dB increments.

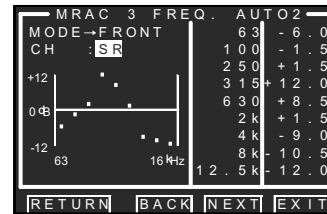

15. Select “**CH**” with the ◀ or ▶ cursor buttons.
16. Move the cursor to “**NEXT**” with the ▲ or ▼ cursor buttons and press the **OK/ENTER** button.

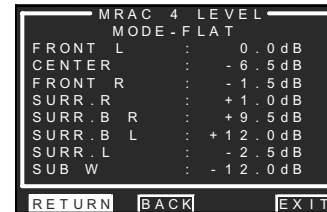

The speaker output level is automatically balanced and indicated in dB by channel.

17. Move the cursor to “**EXIT**” with the ▲, ▼, ◀ and ▶ cursor buttons and press the **OK/ENTER** button to end calibration.

Notes:

- For settings, see the individual settings in “2-2 MANUAL SETUP”.
- To make changes to individual speakers, select “**2. SPEAKER SETUP**” from the MAIN MENU, then select **MANUAL** from the 2-1 SPEAKER SETUP.
- If using a THX certified speaker system, select “**SPEAKER SIZE**” from the MANUAL SETUP menu. Then, turn “**THX SPKR**” on. Move the cursor to “**LPF/HPF**” with the ▲, ▼, ◀ and ▶ cursor buttons and select “**80Hz**” with the ◀ or ▶ cursor buttons.

2-2 MANUAL SETUP

1. Select “**2. SPKR SETUP**” from the MAIN MENU.
2. Select “**MANUAL SETUP**” with the ▲ or ▼ cursor buttons.
3. Press the **OK / ENTER** button to enter the selection.

<SPEAKER SIZE>



When setting the speaker size in the SPEAKER SIZE menu, use the guidelines below.

LARGE:

The complete frequency range for the channel you are setting will be output from the speaker.

SMALL:

Frequencies of the channel you are setting that are lower than approx. 80 Hz will be output from the subwoofer.

If the SUB. W is set to “**NONE**” and the front speakers are set to “**LARGE**,” then the sound will be output from both the left and right speakers.

4. Select each speaker with the ▲ or ▼ cursor buttons.
5. Set the size of each speaker with the ◀ or ▶ cursor buttons.
6. After you complete this portion of the setup, move the cursor to “**NEXT**” with the ▲, ▼, ◀ and ▶ cursor buttons and press the **OK/ENTER** button to go to the next page.

THX SPKR

If you are using a full THX speaker systems which are approved by THX Ltd:

- The front, center and surround speaker size should be “**SMALL**”.
- The subwoofer should be “**YES**”.
- LPF/HPF (the crossover frequency) should be “**80Hz**”.

You need to set the number of surround back speakers and the surround back speaker size should be “**SMALL**”.

SUB W**YES:**

Select when a subwoofer is connected.

NO:

Select when a subwoofer is not connected.

FRONT**LARGE:**

Select if the front speakers are large.

SMALL:

Select if the front speakers are small.

- If “**NO**” is selected for the subwoofer setting, then this setting is fixed at “**LARGE**”.

CENTER**NONE:**

Select if no center speaker is connected.

LARGE:

Select if the center speaker is large.

SMALL:

Select if the center speaker is small.

SURR.**NONE:**

Select if no surround left and right speakers are connected.

LARGE:

Select if the surround left and right speakers are large.

SMALL:

Select if the surround left and right speakers are small.

SURR. B**NONE:**

Select if no surround back left and right speakers are connected.

2CH:

Select if the surround back left and right speakers are connected.

1CH:

Select if one surround back speaker is connected. In this case, the audio signal is emitted from the SURR BACK LEFT output terminal.

Notes:

- If “**NONE**” is selected for the SURR. setting, then this setting is fixed to “**NONE**.”
- You can use SURR. BACK terminals as multiroom speaker terminals when no surround back speaker are connected. (See page 27)

SURR. BACK SIZE**LARGE:**

Select if the surround back speakers are large.

SMALL:

Select if the surround back speakers are small.

Note:

- If “**NONE**” is selected for the SURR. setting, then this setting is not available.

LPF/HPF

When you use a subwoofer, you can select the cutoff frequency for the small speakers used. Select one of the crossover frequency levels according to the size of the small speakers connected.

60Hz → 70Hz → 80Hz → 90Hz → 100Hz → 110Hz → 120Hz → 130Hz → 140Hz → 175Hz → 200Hz

Note:

- If using small front speakers, set a slightly higher frequency. If using large front speakers, set a slightly lower frequency.

BASS MIX

- The bass mix setting is only valid when “**LARGE**” is set for the front speakers and “**YES**” is set for the subwoofer during stereo playback.

This setting has effect only during playback of PCM or analog stereo sources.

- When “**BOTH**” is selected, the low frequencies will be played through the main left and right speakers, as well as the subwoofer.

In this playback mode, the low frequency range expands more uniformly throughout the room, but depending on the size and shape of the room, interference may result in a decrease of the actual volume of the low frequency range.

- By selecting “**MIX**”, the low frequencies will play through the main left and right speakers only.

Note:

- LFE signals during playback of Dolby Digital or DTS will be played through the subwoofer.

- After you complete this portion of the setup, move the cursor to “**NEXT**” with the ▲, ▼, ◀ and ▶ cursor buttons and press the **OK/ENTER** button to go to the next page.

<SPEAKER DISTANCE>

SPEAKER		DISTANCE
UNIT		ft
FRONT L	:	30.00ft
CENTER	:	19.33ft
FRONT R	:	29.66ft
SURR. R	:	21.50ft
SURR. B R	:	12.33ft
SURR. B L	:	100.00ft
SURR. L	:	6.33ft
SUB W	:	12.50ft

RETURN BACK NEXT EXIT

Use this menu to specify the distance of each speaker’s position from the listening position. The delay time is automatically calculated according to these distances.

Begin by determining the ideal or most commonly used seating position in the room.

This is important for the timing of the acoustics to create the proper sound space that the SR9600 and today’s sound systems are able to produce.

Note:

- For speakers for which you have selected “**NONE**”, the speaker configuration sub-menu will not appear here. (There are several useful books and special DVD and LD’s available to guide you through proper home theater configuration. If you are unsure, have your Marantz dealer perform the installation for you. They are trained professionals familiar with even the most sophisticated custom installations. Marantz recommends the www.cedia.org website for further information.)

- Select either **m** (meters) or **ft** (feet) for UNIT with the ◀ or ▶ cursor buttons.

- Select each speaker with the ▲ or ▼ cursor buttons.

- Set the distance for each speaker, press the ◀ or ▶ cursor buttons.

FRONT L:

Select the distance from the front left speaker to your normal listening position.

CENTER:

Select the distance from the center speaker to your normal listening position.

FRONT R:

Select the distance from the front right speaker to your normal listening position.

SURR. L:

Select the distance from the surround left speaker to your normal listening position.

SURR. R:

Select the distance from the surround right speaker to your normal listening position.

SUB W:

Select the distance from the subwoofer to your normal listening position.

SURR. B L:

Select the distance from the surround back left speaker to your normal listening position.

SURR. B R:

Select the distance from the surround back right speaker to your normal listening position.

Notes:

- Set the distance to each speaker in meters (m) or feet (ft) as follows.
m: 0.05 - 30.00 m in 0.05 m steps
ft: 0.16 - 100.00 ft in 0.16 ft steps
(The values appearing on the FL display are approximate.)
- For the speakers that you have selected “**NONE**” the speaker size menu will not appear.
- The setting for surr.back L and surr.back R appears if it is set, two surround back speakers in the SPEAKER SIZE menu.
- The setting of SURR. BACK appears if it is set for one surround back speaker in the SPEAKER SIZE menu.

- After you complete this portion of the setup, move the cursor to “**NEXT**” with the ▲, ▼, ◀ and ▶ cursor buttons and press the **OK/ENTER** button to go to the next page.

<SPEAKER LEVEL>

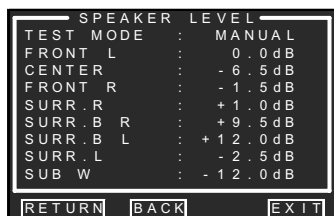

Here you can set the volume for each speaker so that they are all heard by the listener at the same level. We recommend using a SPL (Sound Pressure Level) meter, when available.

Note:

- The speaker level settings are not available in 7.1 Channel Input mode, Pure Direct mode and Source Direct mode.

TEST MODE:

Select "MANUAL" or "AUTO" generation of the test tone with the ◀ or ▶ cursor buttons.

If you select "AUTO", the test tone will be cycled through in a circular pattern beginning at **Left** → **Center** → **Right** → **Surround Right** → **Surround Back Right** → **Surround Back Left** → **Surround Left** → **Subwoofer** → **Left**, in 2 seconds increments for each channel. Using the ◀ or ▶ cursor buttons, adjust the volume level of the noise from the speaker so that it is the same level for all the speakers.

If you select "MANUAL", adjust the output level of each speaker as listed below.

12. Move the cursor to FRONT L by pressing the ▼ cursor button. The SR9600 will emit a pink noise from the front left speaker. Remember the level of this noise and then press the ▼ cursor button. (Note that this can be adjusted to any level between -12 and +12 dB in 0.5 dB increments.) The SR9600 will now emit the pink noise from the center speaker.
13. Using the ◀ and ▶ cursor buttons, adjust the volume level of the noise from the center speaker so that it is the same level as the front left speaker.
14. Press the ▼ cursor button again. The SR9600 will now emit the pink noise from the front right speaker.

15. Repeat steps 13 and 14 for the front right and other speakers until all speakers are adjusted to the same volume level.

After you complete this portion of the setup, press the **OK/ENTER** button to move the cursor to "RETURN". Press the **OK/ENTER** button to go to "2. SPKR SETUP".

Notes:

- Speakers for which you selected "NONE" in the SPEAKER SIZE menu will not appear.
- Surr. Back L and Surr. Back R appear if it is set for two surround back speakers in the SPEAKER SIZE menu.
- Surr. Back appears if it is set for one surround back speaker in the SPEAKER SIZE menu.
- To adjust the speaker levels for 7.1 channel input sources, you will need to use the 7.1 Ch Input sub menu. (See page 33)
- SUB W can be set from -18dB to +12dB.

2-3 THX AUDIO SETUP

You can set the Boundary Gain Compensation and Advanced Speaker Array.

1. Select "2. SPEAKER SETUP" from the MAIN MENU.
2. Select "THX AUDIO SETUP" with the ▲ or ▼ cursor buttons.
3. Press the **OK/ENTER** button to enter the selection.

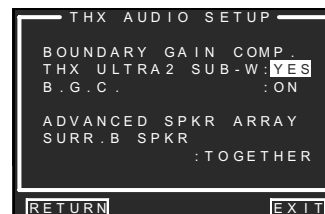

Boundary Gain Compensation

THX ULTRA2 SUB-W : YES or NO

If you have a THX Ultra2 certified subwoofer (or other subwoofer with flat anechoic response to 20 Hz), select "YES".

If set to "YES", you can choose to activate B.G.C. (Boundary Gain Compensation).

If set to "NO", Boundary Gain Compensation may not be activated and the feature is locked out.

B.G.C.: ON or OFF

OFF: Boundary Gain Compensation is not applied.
ON: Boundary Gain Compensation is applied.

Notes:

- If you set **SUB W = NO** in SPEAKER SIZE menu, Boundary Gain Compensation will not be activated. THX ULTRA2 SUB-W also cannot be set.
- If you set **THX ULTRA2 SUB-W = YES**, the Bass Peak Level setting is not applied.

Advanced Speaker Array (ASA)

SURR.B SPKR: TOGETHER, CLOSE or APART

The best ASA effect is when the surround back speakers are together and facing forward.

If the distance between the surround back speakers is,

- Less than **12 in.** (30 cm): **TOGETHER**
- Greater than **12 in.** (30 cm), and less than **48 in.** (122 cm): **CLOSE**
- Greater than **48 in.** (122 cm): **APART**

Speaker type and positioning

This diagram shows the desired positioning for 7.1 channel speaker systems used in ASA mode. During system setup, select the distance between surround back speakers.

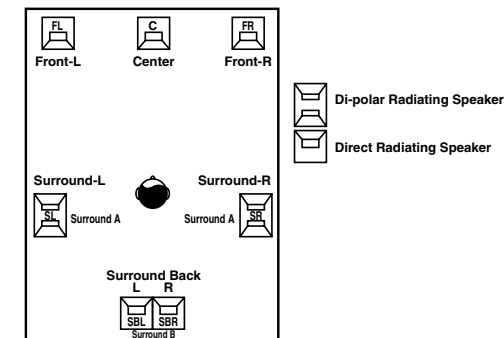

Note:

- If you set **SURR.B = ICH or NONE** in the SPEAKER SIZE menu, Advanced Speaker Array will not be activated.

After you complete this portion of the setup, move the cursor to "RETURN" with ▲, ▼, ◀ and ▶ cursor buttons and press **OK/ENTER** button to go to the 2. SPKR SETUP menu.

2-4 BASS PEAK LEVEL

1. Select "**2. SPEAKER SETUP**" from the MAIN MENU.
2. Select "**BASS PEAK LEVEL**" with the ▲ or ▼ cursor buttons.
3. Press the **OK/ENTER** button to enter the selection.

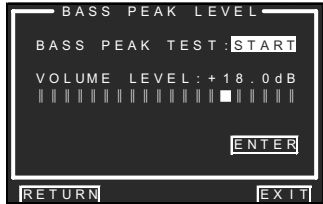

With Dolby Digital and DTS, not only the LFE (Low Frequency Effects), but also the bass of all channels can be heard from the subwoofer or large speakers. This procedure prevents these speakers from becoming too loud and creating an unbalanced sound. Since the sound is output at a loud volume, perform this operation carefully.

Note:

- If your system does not include a subwoofer, this setting will set the bass peak level for your front speakers.

TEST SIGNAL: Press the ◀ or ▶ button.

"**START**" is displayed and a bass test tone is generated from the speaker which was designated for bass signal output during setup. There will be no audible sound yet because the master volume is set to minimum automatically.

VOLUME LEVEL: Adjust the bass test tone output level up until the bass begins to distort or you reach the maximum level with the ◀ or ▶ cursor button.

ENTER: Press the **OK** button, "**ENTER**" will blink and the bass peak test tone will no longer be generated. The bass peak limit level for your system has now been memorized.

After you complete this portion of the setup, move the cursor to "RETURN" with ▲, ▼, ◀ and ▶ cursor buttons and press **OK/ENTER** button to go to the 2. SPKR SETUP menu.

Notes:

- Each time the subwoofer level is changed, perform the bass peak level setup and correct the setting.
- The bass peak level is not available in Pure Direct and Source Direct mode.
- The selected value is displayed in the volume column before the test signal starts.

3 SURROUND SETUP

This menu is for setting surround effect parameters for the various surround input signals so as to bring out the live audio effect of your speaker system.

- **CHANNEL LEVEL:**
"3-1 CHANNEL LEVEL" (see page 41)
- **PLIIx MUSIC PARAMETER:**
"3-2 PLIIx MUSIC PARAMETER" (see page 42)
- **CSII/TS XT PARAMETER:**
"3-3 CSII / TS XT PARAMETER" (see page 42)
- **NEO:6 PARAMETER:**
"3-4 NEO:6 PARAMETER" (see page 42)

1. Select "3. SURR SETUP" from the MAIN MENU with the ▲ or ▼ cursor buttons and press the OK/ENTER button.
2. Select the desired menu with the ▲ or ▼ cursor buttons and press the OK/ENTER button.



RE-EQ:

Turns THX Cinema Re-EQ™ on and off. Select the Cinema Re-EQ™ with the ◀ or ▶ cursor button to activate it.

LFE LEVEL:

Select the output level of the LFE signal included in the Dolby Digital signal or the DTS signal. Select "0dB", "-10 dB" or "OFF" with ◀ or ▶ cursor button.

After you complete this portion of the setup, move the cursor to "RETURN" with the ▲, ▼, ◀, ▶ cursor buttons and press the OK/ENTER button.

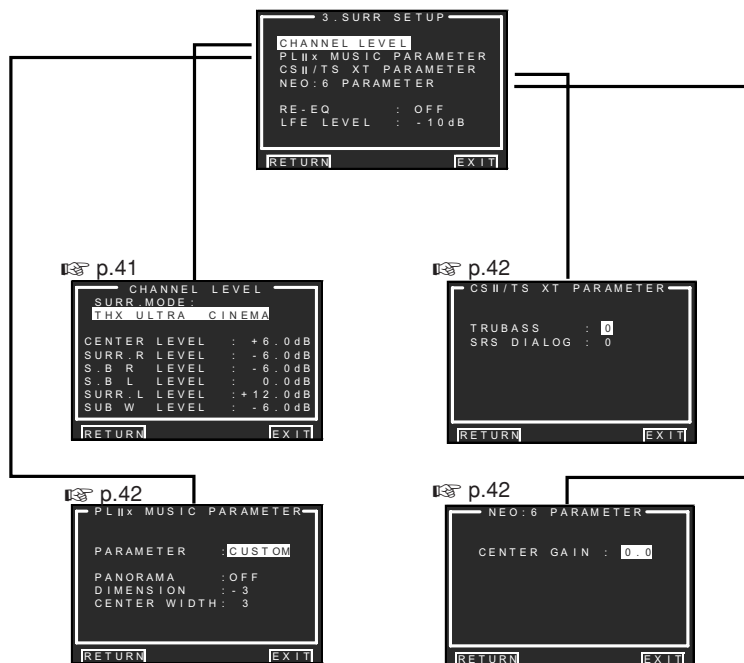

Note:

- After you complete this portion of the setup, press the OK/ENTER button to move the cursor to "RETURN" and press the OK/ENTER button again to go to sub-menu.

3-1 CHANNEL LEVEL

1. Select "3. SURR SETUP" from MAIN MENU with ▲ or ▼ cursor buttons and press the OK/ENTER button.
2. Select "CHANNEL LEVEL" with the ▲ or ▼ cursor buttons and press the OK/ENTER button.
3. Set the SURR. MODE with the ◀ or ▶ cursor buttons.

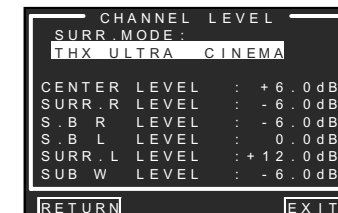

4. Select the desired menu item with the ▲ or ▼ cursor buttons, set the desired level with the ◀ or ▶ cursor buttons, and press the OK/ENTER button.

SURROUND MODE:

The surround mode can be independently set for 3 modes.

1. Multi Ch STEREO
2. CSII
3. Others

CHANNEL LEVEL

CENTER LEVEL:

Set the effect level of the center speaker between -12 and +12 level in 0.5 level interval .

- If "NONE" was selected for the center speaker setting in the SPEAKER SIZE, then this setting will not appear.

SURR L or R LEVEL:

Set the effect level of the Surround speaker between -12 and +12 level in 0.5 level interval .

- If "NONE" was selected for the surround speakers setting in the SPEAKER SIZE, then this setting will not appear.

S. B L or R LEVEL:

Set the effect level of the Surround Back speaker between -12 and +12 level in 0.5 level interval .

- If "NONE" was selected for the surround back speakers setting in the SPEAKER SIZE, then this setting will not appear.

SUB W LEVEL:

Set the effect level of the subwoofer speaker between **-18** and **+12** level in 0.5 level interval .

- If “NONE” was selected for the subwoofer speaker setting in the SPEAKER SIZE, then this setting will not appear.

Note:

- Setting to a mode other than multichannel stereo or CSII will affect the speaker level as explained in "2-2 MANUAL SETUP".

After you complete this portion of the setup, move the cursor to “RETURN” with the ▲, ▼, ◀ and ▶ cursor buttons and press the **OK/ENTER** button to go to the 3. SURR SETUP menu.

3-2 PLIIx (PRO LOGIC IIx) MUSIC PARAMETER

Pro LogicIIx-Music mode creates a rich and enveloping surround ambience from stereo sources such as CDs.

In this mode, the SR9600 includes three controls to fine-tune the sound field as follows.

1. Select “**3. SURR SETUP**” in MAIN MENU with ▲ or ▼ cursor buttons and press the **OK/ENTER** button.
2. Select “**PLIIx MUSIC PARAMETER**” with the ▲ or ▼ cursor buttons.
3. Press the **OK/ENTER** button to enter the selection.

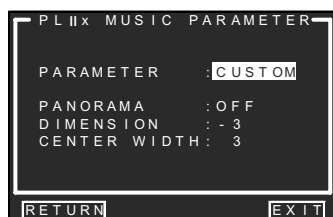
**PARAMETER:**

Select “**DEFAULT**” or “**CUSTOM**” with the ◀ or ▶ cursor buttons.

If you select “**CUSTOM**”, you can adjust three parameters as listed below.

PANORAMA:

Select the PANORAMA mode “**ON**” or “**OFF**” with the ◀ or ▶ cursor buttons.

Panorama wraps the sound of the front left and right speakers around you, for an exciting perspective.

DIMENSION:

Set the DIMENSION level between **-3** and **+3** level in 1 level intervals with the ◀ or ▶ cursor buttons.

Adjust the sound field either towards the front or towards the rear.

This can be useful to help achieve a more suitable balance from all the speakers with certain recordings.

CENTER WIDTH:

Set the CENTER WIDTH level between **0** and **7** in 1 level intervals with the ◀ or ▶ cursor buttons.

Center width allows you to gradually spread the center channel sound into the front left and right speakers.

At its widest setting, all the sound from the center is mixed into the left and right speakers. This control may help achieve a more spacious sound or a better blend for the front image.

If “**NONE**” was selected for the center speaker setting in the SPEAKER SIZE menu, this setting cannot be selected.

After you complete this portion of the setup, move cursor to “**RETURN**” with the ▲, ▼, ◀ and ▶ cursor buttons and press the **OK/ENTER** button.

3-3 CSII/TS XT PARAMETER

1. Select “**3. SURROUND SETUP**” from MAIN MENU with the ▲ or ▼ cursor buttons and press the **OK/ENTER** button.
2. Select “**CS II/TS XT PARAMETER**” with the ▲ or ▼ cursor buttons.
3. Press the **OK/ENTER** button to enter the selection.

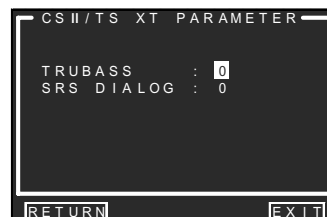
**TRUBASS:**

Set the TRUBASS level between **0** and **6** in 1-level increments with the ◀ or ▶ cursor buttons. TRUBASS produced by the speakers are an octave below the actual physical capabilities of the speakers adding exciting, deeper bass effects.

SRS DIALOG:

Set the SRS DIALOG level between **0** and **6** in 1- increments with the ◀ or ▶ cursor buttons. This can be popped out of the surround audio effects, allowing the listener to easily discern what the actors say.

If “**NONE**” was selected for the center speaker setting in the SPEAKER SIZE menu, this setting cannot be selected.

After you complete this portion of the setup, move cursor to “**RETURN**” with the ▲, ▼, ◀ and ▶ cursor buttons and press the **OK/ENTER** button.

Note:

- This parameter can only be set in the CSII and Virtual (TruSurround XT) modes.

3-4 NEO:6 PARAMETER

The DTS NEO:6 mode enables a maximum 6.1 channel output with just 2 channel input. (It also supports 5.1 channel input.)

This mode expands the sound image from the center channel.

1. Select “**3. SURROUND SETUP**” from MAIN MENU with the ▲ or ▼ cursor buttons and press the **OK/ENTER** button.
2. Select “**NEO:6 PARAMETER**” with the ▲ or ▼ cursor buttons.
3. Press the **OK/ENTER** button to enter the selection.

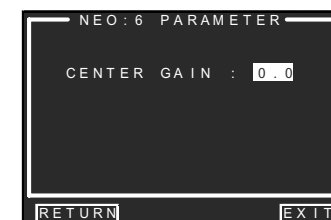

4. Set the CENTER GAIN level between 0.0 and 1.0 in 0.1 level increments with the ◀ or ▶ cursor buttons.

After you complete this portion of the setup, move cursor to “**RETURN**” with the ▲, ▼, ◀ and ▶ cursor buttons and press the **OK/ENTER** button.

Notes:

- This parameter can only be set in the NEO:6-Music mode.
- If “**NONE**” was selected for the center speaker setting in the SPEAKER SIZE menu, this setting is disabled.

4 VIDEO SETUP

This menu is for configuring video settings.

- **VIDEO AUTO ON :**
"4-1 VIDEO AUTO ON" (see page 43)
- **VIDEO COLOR BAR :**
"4-2 VIDEO COLOR BAR" (see page 43)

1. Select "**4. VIDEO SETUP**" from MAIN MENU with the ▲ or ▼ cursor buttons and press the **OK/ENTER** button.

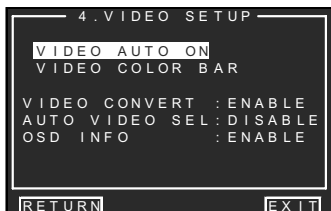

2. Select the desired menu with the ▲ or ▼ cursor buttons and press the **OK/ENTER** button.

VIDEO CONVERT:

Select the VIDEO CONVERT function to "**ENABLE**" or "**DISABLE**" with the ◀ or ▶ cursor buttons.

(Video cable connection: See page 48)

AUTO VIDEO SEL:

Select the AUTO VIDEO SEL function to "**ENABLE**" or "**DISABLE**" with the ◀ or ▶ cursor buttons. (See page 55)

OSD INFO:

Select the OSD information function to "**ENABLE**" or "**DISABLE**" with the ◀ or ▶ cursor buttons.

If you select "**ENABLE**", the SR9600 will display the status of the feature (Volume up/down, input select, etc..) on the monitor. If you do not desire this information, select "**DISABLE**".

After you complete this portion of the setup, move cursor to "**RETURN**" with the ▲, ▼, ◀ and ▶ cursor buttons and press the **OK/ENTER** button.

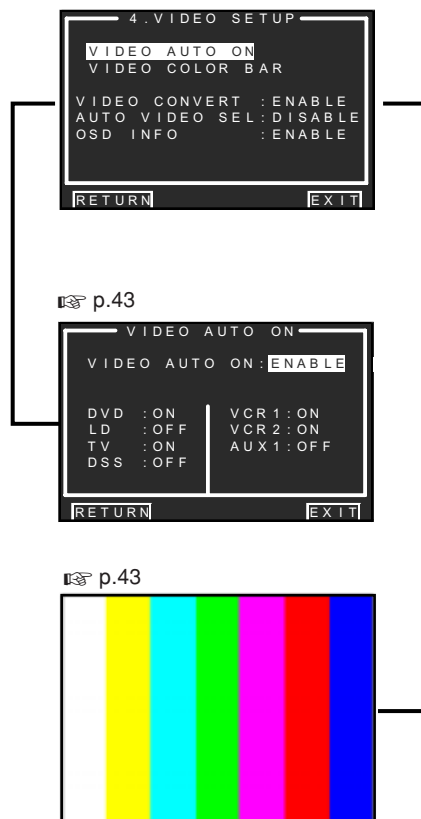

4-1 VIDEO AUTO ON

This menu is for synchronizing the SR9600 with video components so that they can be powered up automatically and enter standby at the same time as the SR9600. Settings can be entered separately for each input source.

1. Select "**4. VIDEO SETUP**" from MAIN MENU with the ▲ or ▼ cursor buttons and press the **OK/ENTER** button.
2. Select "**VIDEO AUTO ON**" with the ▲ or ▼ cursor button.
3. Press the **OK/ENTER** button to enter the selection.

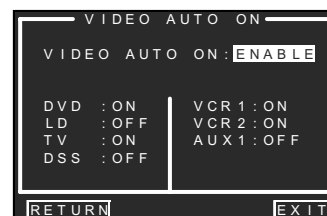

4. Select the desired menu with the ▲ or ▼ cursor buttons, and press the **OK/ENTER** button.

VIDEO AUTO ON:

Select "**ENABLE**" or "**DISABLE**".

Video function:

Set to "**ON**" or "**OFF**" with the ◀ or ▶ cursor buttons.

After you complete this portion of the setup, move cursor to "**RETURN**" with the ▲, ▼, ◀ and ▶ cursor buttons and press the **OK/ENTER** button.

Note:

- VIDEO AUTO ON and RS232C are disabled in the "**ECONOMY STANDBY**" setting. (See page 55)

4-2 VIDEO COLOR BAR

1. Select "**4. VIDEO SETUP**" from MAIN MENU with the ▲ or ▼ cursor buttons and press the **OK/ENTER** button.
2. Select "**VIDEO COLOR BAR**" with the ▲ or ▼ cursor buttons.
3. Press the **OK/ENTER** button to enter the selection. Color bars appear on the video display connected to the SR9600.
4. Press the **OK/ENTER** button again to return to the 4. VIDEO SETUP menu.

Note:

- Color bars are not output to the video and S-video jacks.

5 PREFERENCE

- **MULTI ROOM SETUP :**
"5-1 MULTI ROOM SETUP" (see page 44)
- **DC TRIGGER SETUP :**
"5-2 DC TRIGGER SETUP" (see page 45)

1. Select "**5. PREFERENCE**" from MAIN MENU with the **▲** or **▼** cursor buttons and press the **OK/ENTER** button.

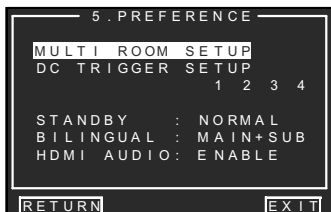

2. Select the desired menu with the **▲** or **▼** cursor buttons and press the **OK/ENTER** button.

STAND BY:

When this is set to "**ECONOMY**", you can reduce the power consumption when the unit is in the Standby mode. When "**ECONOMY**" is selected, "**Video Auto On**" and "**RS-232C**" are disabled when the unit is in the Standby mode.

BILINGUAL:

In the Bilingual mode, Dolby Digital and DTS output is set to either "**MAIN**" or "**SUB**". Select "**BILINGUAL**" with the **▲** and **▼** cursor buttons, then select **MAIN** ↔ **SUB** ↔ **MAIN+SUB** with the **▲** or **▼** cursor buttons.

HDMI AUDIO:

This setting determines whether to play back audio input to the HDMI jacks through the SR9600 or output it through the receiver to a TV or projector.

ENABLE: The audio input to the HDMI jacks can be played back by this receiver. In such case, audio signals are not output to the TV or projector.

THROUGH: The audio input to the HDMI jacks is not output from the speaker terminals of the SR9600. Audio data is output directly to the TV or projector. This setting is used to listen to audio on a multi channel TV, etc. When this mode has been selected, "**HDMI THR**" appears on the FL display.

p.44

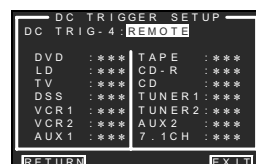
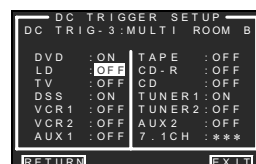
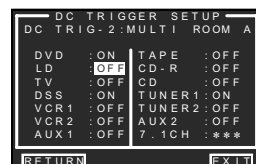
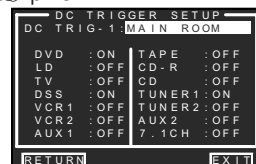

p.45

**Note:**

- After you complete this portion of the setup, press the **OK/ENTER** button to move the cursor to "**RETURN**" and press the **OK/ENTER** button to go to the sub menu.

5-1 MULTI ROOM SETUP

SR9600 has features for 2 multiroom systems such as source selector, sleep timer, multiroom speaker output and remote control. You can set these features in this menu.

1. Select "**5. PREFERENCE**" from MAIN MENU with the **▲** or **▼** cursor buttons and press the **OK/ENTER** button.
2. Select "**MULTI ROOM SETUP**" with the **▲** or **▼** cursor buttons.
3. Press the **OK/ENTER** button to enter the selection.

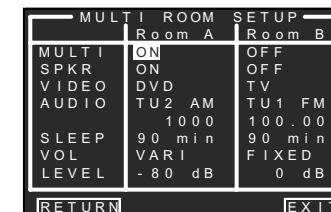

4. Select the desired item with the **▲** or **▼** cursor button.

MULTI (MULTI ROOM):

To switch the multiroom output "**ON**" or "**OFF**" with the **◀** or **▶** cursor buttons.

SPKR (SPEAKER):

To switch the speaker output "**ON**" or "**OFF**" with the **◀** or **▶** cursor buttons.

VIDEO:

Select the video source of the multiroom output with the **◀** or **▶** cursor buttons.

AUDIO:

Select the audio source of the multiroom output with the **◀** or **▶** cursor buttons.

SLEEP:

The sleep mode is available when the multiroom is active, set the time with **◀** or **▶** cursor buttons. The sleep timer can be set to a maximum 90 minutes in 10 minute increments.

VOL (VOLUME SETUP):

Select whether the multiroom output level is variable or fixed with the **◀** or **▶** cursor buttons.

LEVEL (VOLUME LEVEL):

Adjust the multiroom output level with the **◀** or **▶** cursor buttons. The volume can be set between -90 dB and 0 dB in 1 dB increments.

Note:

- This setting can be changed when the SURR B is set to “NONE” in the SPEAKER SIZE menu and “SPEAKER C” is in the OFF position on the rear panel. When this setting is unavailable, “***” is displayed.
- If “VOLUME” is set to “FIXED”, the multiroom output level cannot be adjusted from the A or B room.
- SPKR cannot be on for both Room A and Room B at the same time.

After you complete this portion of the setup, move the cursor to “RETURN” with the ▲ or ▼ cursor buttons and press the OK/ENTER button.

5-2 DC TRIGGER SETUP

This unit has 4 DC trigger control jacks, which can be used to link with input functions for the main room or multiroom. Each trigger can be setup separately.

1. Select “5. PREFERENCE” from MAIN MENU with the ▲ or ▼ cursor buttons and press the OK/ENTER button.
2. Select “DC TRIGGER SETUP” with the ▲, ▼, ◀, and ▶ cursor buttons.
3. Press the OK/ENTER button to enter the selection.

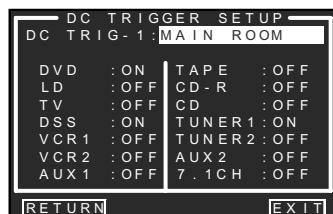

4. You can select “MAIN ROOM”, “MULTI ROOM A”, “MULTI ROOM B”, “REMOTE” or “DISABLE” with the ◀ or ▶ cursor buttons.

Note:

- When set to “REMOTE”, DC trigger output can be controlled from RC3200B.

5. Select desired input source with the ▲ or ▼ cursor buttons.
6. Set to “ON” or “OFF” with the ◀ or ▶ cursor buttons.
7. After you complete this portion of the setup, move the cursor to “RETURN” with the ▲ or ▼ cursor button and press the OK/ENTER button.

Note:

- When an input source that is on in the set room is selected, voltage is output to the DC TRIGGER output terminal.

6 ACOUSTIC EQ

This display is for setting up the equalizer and changing the Equalizer mode.

- **PRESET G. EQ 1 & 2 ADJ :**
 "6-1 PRESET G. EQ 1 & 2 ADJ" (see page 47)
- **CHECK AUTO 1 & 2 :**
 "6-2 CHECK AUTO 1 & 2" (see page 47)

EQ MODE:

Set to one of the 4 equalizer modes, either from the manual modes (PRESET G. EQ 1/2) or the auto modes set by the MRAC mode (AUTO 1/2). Set to "OFF" if not using the equalizer.

1. Select "6. ACOUSTIC EQ" from MAIN MENU with the ▲ or ▼ cursor buttons and press the **OK/ENTER** button.

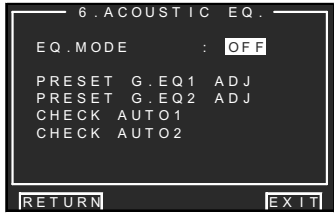

2. Select "EQ. MODE" with the ▲ or ▼ cursor buttons.
3. Select "EQ1", "EQ2", "AUTO1", "AUTO2" or "OFF" with the ◀ or ▶ cursor buttons.

After you complete this portion of the setup, move the cursor to "RETURN" with the ▲, ▼, ◀ and ▶ cursor buttons and press the **OK/ENTER** button.

Note:

- The equalizer is not available in the Source Direct, Pure Direct, Dolby Headphone and 192kHz PCM modes.

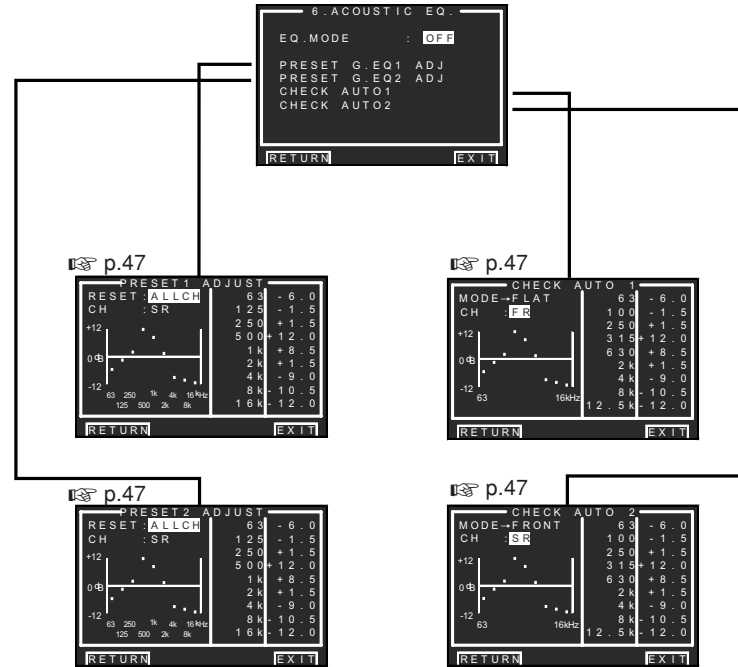

6-1 PRESET G. EQ 1 & 2 ADJ

These modes allow you to set a 9-band graphic equalizer for each of the 7 channels.

1. Select “**6. ACOUSTIC EQ**” from MAIN MENU with the ▲ or ▼ cursor buttons and press the **OK/ENTER** button.
2. Select “**PRESET G. EQ 1 ADJ (or PRESET G. EQ 2 ADJ)**” with the ▲ or ▼ cursor buttons.
3. Press the **OK/ENTER** button to enter the selection.



RESET:

Using the ◀ or ▶ cursor buttons, select the channel(s) to be reset to either the currently displayed channel (“**THIS**”) or all channels (“**ALLCH**”), and press the **OK/ENTER** button to enter the setting.

CH:

Select the channel (“**FL**”, “**C**”, “**FR**”, “**SR**”, “**SBL**”, “**SBR**” or “**SL**”) to adjust with the ◀ or ▶ cursor buttons, and switch to the adjustment mode with the ▼ cursor button.

Frequency:

Select the target frequency on the graph with the ◀ or ▶ cursor buttons and press the **OK/ENTER** button to enter the selection. Adjust the level with the ▲ or ▼ cursor buttons. (Note that this can be adjusted to any level between **-12** and **+12** dB in 0.5 dB increments.) Press the **OK/ENTER** button to enter the setting.

Move to the next frequency with the ◀ or ▶ cursor buttons, and adjust the level.

After you complete this portion of the setup, move cursor to “**RETURN**” with the ▲, ▼, ◀ and ▶ cursor buttons and press the **OK/ENTER** button.

6-2 CHECK AUTO 1 & 2

These menus are for confirming the results of MRAC equalizer measurement (AUTO 1/2).

1. Select “**6. ACOUSTIC EQ**” from MAIN MENU with the ▲ or ▼ cursor buttons and press the **OK/ENTER** button.
2. Select “**CHECK AUTO 1 (or CHECK AUTO 2)**” with the ▲ or ▼ cursor buttons.
3. Press the **OK/ENTER** button to enter the selection.

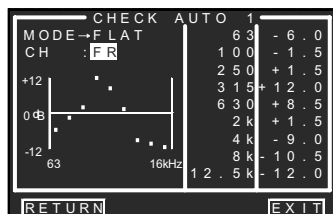

The CHECK AUTO 1 menu displays the frequency which is automatically compensated for the flat level of the all channels.

The CHECK AUTO 2 menu displays the frequency which is automatically compensated for the front speaker characteristics.

CH:

Select the channel to check with the ◀ or ▶ cursor buttons.

Note:

- The frequency will not be exactly the same as in the Preset G. EQ modes.
- FL and FR are not indicated on the CHECK AUTO 2 menu.

Select “**RETURN**”, press the ▲ or ▼ cursor buttons and press the **OK/ENTER** button to go to “**6. ACOUSTIC EQ.**”.

7 AUDIO STATUS

This menu provides current audio information.

1. Select “**7. STATUS**” from MAIN MENU with the ▲ or ▼ cursor buttons and press the **OK/ENTER** button.

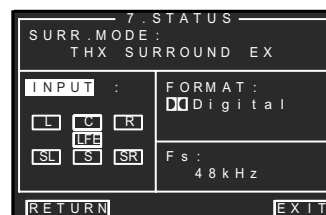

SURR. MODE:

Displays the selected surround mode.

FORMAT:

Displays the audio format of the input source.

Fs:

Displays the sampling frequency of the input source.

INPUT (OUTPUT)

Select “**INPUT**” or “**OUTPUT**” with the ◀ or ▶ cursor buttons.

INPUT:

Displays the input channel of the source signal.

OUTPUT:

Displays the output channel.

To select “**RETURN**” with the ▲, ▼, ◀ and ▶ cursor buttons and press the **OK/ENTER** button to go to MAIN MENU.

Note:

When playing back a disk such as an SACD or DVD-Audio disk via i.LINK or HDMI, the actual audio and display may not match with some DVD players.

BASIC OPERATION (PLAYBACK)

The remote control operations in this chapter are performed with the remote control unit set to the A/V Amp mode. To set the Amp mode, press the **A/V Amp** button on the Home menu of the remote control unit.

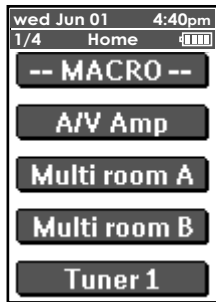

SELECTING AN INPUT SOURCE

Before you can listen to any input media, you must first select the input source on the SR9600.

Example: DVD

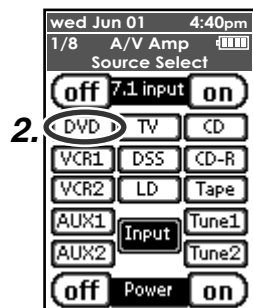
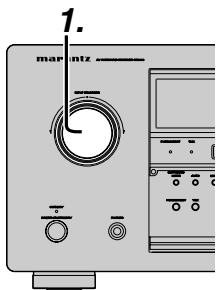

1. Select "DVD" by turning the **INPUT SELECTOR** knob on the front panel.
Or, tap the **"A/V Amp"** on the remote control unit and press the **page up** button until page 1/8 is displayed. Press the **"DVD"**.
2. After you have selected "DVD", simply turn on the DVD player and play the DVD.

- As the input source is changed, the new input name will appear momentarily on the video display. The input name will also appear in the FL display on the front panel.

- As the input source is changed, the SR9600 will automatically switch to the digital input, surround mode, attenuation, and night mode status which were entered during the configuration process for that source.
- When an audio source is selected, the last video input used remains routed to the VCR-1 & VCR-2/DVD-R OUTPUT and MONITOR OUTPUT. This permits simultaneous viewing and listening to different sources.
- When a video source is selected, the video signal for that input will be routed to the MONITOR OUTPUT jacks and will be viewable on a TV monitor connected to the SR9600.
If a component video input is connected to the COMPONENT 1 to 4 inputs, it will be routed to the COMPONENT VIDEO OUTPUT. Make certain that your TV is set to the proper input to view the signal.

i.LINK FUNCTION

When an audio-supporting i.LINK device (source devices only) is newly connected to the SR9600, a temporary input source item specifically for the i.LINK device is added between "DVD" and "AUX2". It can be selected using the INPUT SELECTOR knob or via the **Input** button on the remote control unit.

EXAMPLE: WHEN "DVxxxx" OR "SAxxxx" i.LINK DEVICE HAS BEEN NEWLY CONNECTED TO THE SR9600

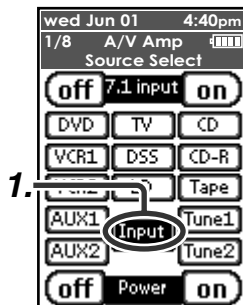
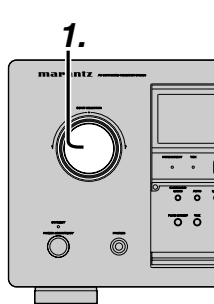

1. Select "DVxxxx" or "SAxxxx" by turning the **INPUT SELECTOR** knob on the front panel.
Or, tap the **"A/V Amp"** on the remote control unit and press the **page up** button until page 1/8 is displayed. Press the **"Input"**.

The input sources are displayed on the FL display in the following order.

DVD ↔ LD ↔ TV ↔ DSS ↔ VCR1 ↔ VCR2 ↔ AUX1 ↔ TAPE ↔ CD-R ↔ CD ↔ TUNER1 ↔ TUNER2 ↔ AUX2 ↔ DVxxxx ↔ SAxxxx ↔ DVD...

Notes:

- "NO NAME" appears for devices for which there is no name information.
- Analog/digital input cannot be switched. (See page 56)
- The last selected input source is selected as the video signal.

The temporary input source item for the i.LINK device disappears in the following cases. In such case, the selection returns to the last selected input source.

- If the i.LINK device is disconnected or power to the i.LINK device is turned off
- If the i.LINK device is assigned as an input source
- If power to the SR9600 is tuned off

VIDEO CONVERT

When this mode is activated, the video or S-video signal can be emitted from the VIDEO, S-VIDEO or COMPONENT VIDEO output terminal. To activate this mode, select "VIDEO CONVERT" from "4. VIDEO SETUP" menu and set "ENABLE".

Notes:

- The component video signal is emitted only from the COMPONENT VIDEO output terminal. When the video equipment is connected to component terminals, connect the monitor and SR9600 using the component terminals.
- This mode is unavailable for the REC out terminal.
- This mode is unavailable for still picture, fast forward and reverse play on video component.
- If, while attempting to use the video convert feature, the SR9600 cannot synchronize with the display device, "NO SIGNAL" appears on the monitor or noise is generated, this feature cannot be used. All of these signs are caused by equipment incompatibility; there is nothing wrong with the SR9600.

If this occurs, set "VIDEO CONVERT" in the "VIDEO SETUP" menu to "DISABLE". Next, connect the video input signal to the display component via the MONITOR OUT terminal under VIDEO and the S-video input signal to the display component via the MONITOR OUT terminal under S-VIDEO.

- The video convert feature constantly monitors input video signals and determines whether to convert the input signals or not. However, some input video signals cannot be detected correctly.

If this occurs, set "VIDEO CONVERT" in the "VIDEO SETUP" menu to "DISABLE".

Example:

Monitor is connected via component terminals.

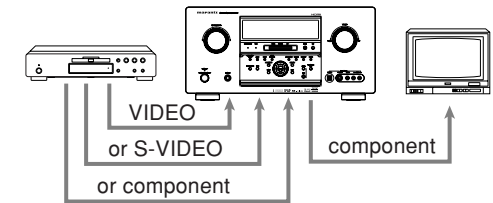

Monitor is connected via the video or S-video terminals.

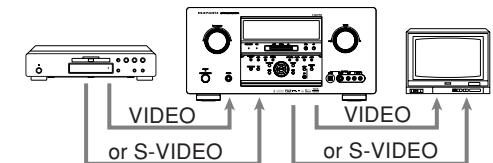

The signal cannot be converted from component to video or S-video.

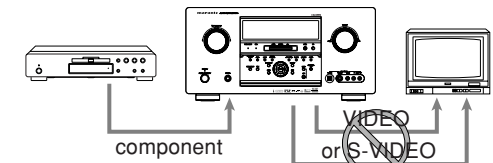

Notes of OSD menu system :

- The setup menu can be displayed through all video out terminals ("COMPONENT", "S-VIDEO", and "VIDEO").
- Setting information (e.g. volume setting) is displayed through VIDEO and S-VIDEO out terminals when the VIDEO CONVERT function is set to "ENABLE".

Note:

No setting information is displayed when the signal is emitted from the COMPONENT IN to COMPONENT OUT.

- Setting information (e.g. volume setting) is displayed through the S-VIDEO or VIDEO outputs when the VIDEO CONVERT function is set to "DISABLE". When the S-VIDEO and VIDEO outputs are used simultaneously, the setting information is displayed through the S-VIDEO output only.

SELECTING THE SURROUND MODE

Using the SR9600

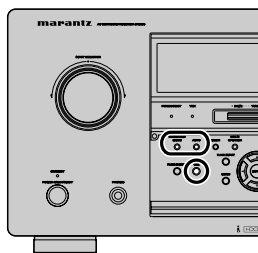

To select the auto surround mode during playback, press the **AUTO** button on the front panel.
To add the THX effect to the Auto Surround mode, press the **THX** button on the front panel.
To select a specific surround mode, press the **SURROUND MODE** button on the front panel.

Using the remote control unit

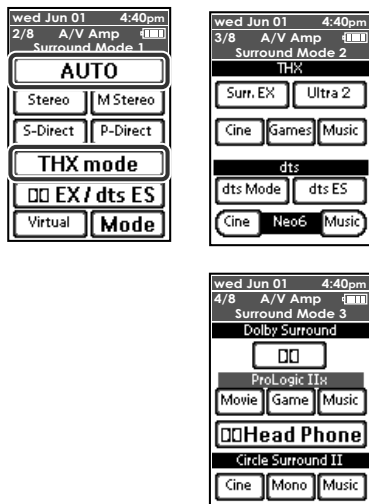

To select the auto surround mode, tap the **A/V Amp** and press the **page up** button until page 2/8 is displayed. Tap the **AUTO**.
To add the THX effect to the Auto Surround mode, tap the **THX mode** button on page 2/8 of the remote control unit.
To select a specific surround mode, tap the **mode** button on pages 2/8 to 4/8 on the remote control unit.

ADJUSTING THE MAIN VOLUME

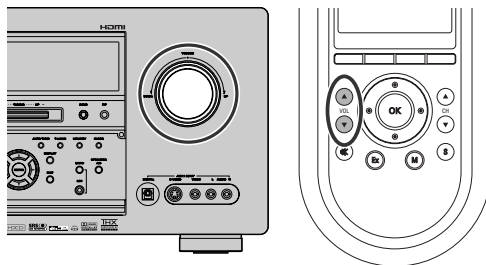

Adjust the volume to a comfortable level using the **VOLUME** control knob on the front panel or the **VOL ▲ / ▼** buttons on the remote control unit.
To increase the volume, turn the **VOLUME** knob clockwise or press **VOL ▲** button on the remote control unit, and to decrease the volume, turn counterclockwise or press **VOL ▼** button on the remote control unit.

Notes:

- The volume can be adjusted within the range of $-\infty$ to +18 dB, in 0.5 dB.
- However, when the channel level is set as described on page 39, if the volume for any channel is set at +1 dB or greater, the volume cannot be adjusted up to 18 dB.
(In this case the maximum volume adjustment range is 18 dB)

ADJUSTING THE TONE (BASS & TREBLE) CONTROL

During a listening session you may wish to adjust the bass and treble control to suit your listening tastes or room acoustics.



To adjust the tone, tap the **A/V Amp** and press the **page up** button until page 6/8 is displayed.
To adjust the bass effect, tap **Bass +** or **Bass -**.
To adjust the treble effect, tap **Treble +** or **Treble -**.

Note:

- The tone control function is unavailable for the Virtual, Source Direct, Pure Direct, Dolby Headphone, THX mode, and 192kHz PCM.

TEMPORARILY TURNING OFF THE SOUND

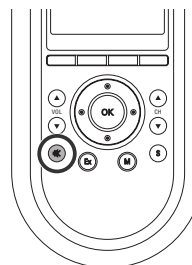

To temporarily silence all speaker outputs such as when interrupted by a phone call, press the **MUTE** button on the remote.
This will interrupt the output to all speakers and the head phone jack, but it will not affect any recording or dubbing that may be in progress.
When the system is muted, **MUTE** appears on the display.
Press the **MUTE** button again to return to normal operation.

USING THE SLEEP TIMER

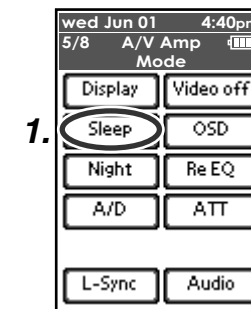

- To program the SR9600 for automatic standby, tap the **Sleep** on the remote control unit.
Each tap of the button will increase the time before shutdown in the following sequence:

OFF	10	20	30	40
90	80	70	60	50
- The sleep time will be shown for a few seconds on the FL display, and it will count down until the time has elapsed.
When the programmed sleep time has elapsed, the SR9600 will automatically turn off.
Note that the **SLEEP** indicator on the FL display will illuminate when the sleep mode is set.
- To cancel the sleep mode, tap the **Sleep** until the **SLEEP OFF** and the **SLEEP** indicator disappear.

NIGHT MODE

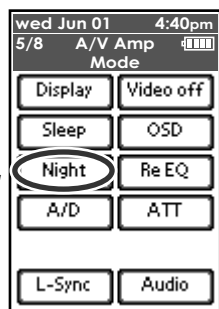

1. Tap the **Night** on the remote control unit to turn on the Night mode.
Setting the Night mode to "ON" compresses the dynamic range in Dolby Digital only. This softens loud passages such as sudden explosions, to help prevent disturbing others late at night.
2. To turn off the Night mode, tap the **Night** again.

DIALOGUE NORMALIZATION MESSAGE

Dialogue Normalization (Dial Norm) is a feature of Dolby Digital.

When playing back software which has been encoded in Dolby Digital, sometimes you may see a brief message on the FL display which will read "Dial Norm X dB" (X being a numeric value).

Dialogue Normalization serves to let you know if the source material has been recorded at a higher or lower level than usual. For example, if you see the following message: "Dial Norm + 4 dB" on the FL display, to keep the overall output level constant just turn down the volume control by 4 dB. In other words, the source material that you are listening to has been recorded 4 dB louder than usual.

If you do not see a message on the FL display, then no adjustment of the volume control is necessary.

RE-EQ

This menu is for turning THX Cinema Re-EQ™ on and off. The tonal balance of a film soundtrack will be excessively bright and harsh when played back over audio equipment in the home. This is because film soundtracks were designed to be played back in large movie theater environments.

Activating the Cinema Re-EQ™ mode when watching a film made for movie theaters corrects this and restores the correct tonal balance.

Cinema Re-EQ™ is therefore not necessary for material that was not designed for movie theaters (for example, sports programming, television shows, made for TV movies, etc.).

The Cinema Re-EQ™ mode can be activated only while in Dolby Pro Logic mode, or while decoding Dolby Digital or DTS-encoded material.

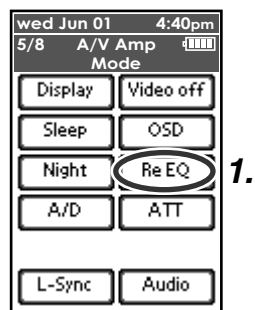

1. Tap the **Re EQ** on the remote control unit to turn on the Re-EQ™ mode.
2. To turn off the Re-EQ™ mode, tap the **Re EQ** again.

Note:

- The Re-EQ™ mode can be selected from the OSD menu system. (See page 41)

LIP.SYNC

Depending on the display component (TV, monitor, projector, etc.) connected to the SR9600, a time lag can occur between image signal processing and audio signal processing. Though minor, this time lag can interfere with movie and music enjoyment. The Lip.Sync mode delays the audio signal with respect to the image signal output from the SR9600 to correct the time lag between the sound and image.

1. Tap the **A/V Amp** and press the **page up** button until page 5/8 is displayed. Tap the **L-Sync** on the remote control unit.



2. Select the time lag with the ◀ and ▶ cursor buttons on the remote control unit.

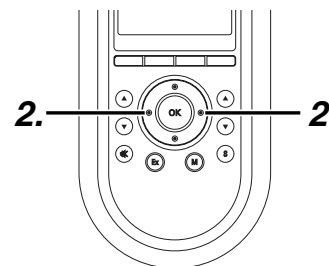

The initial setting is "OFF" (0 ms). The time lag can be adjusted in 10 ms increments up to 200 ms.

Watch the picture on the image device (e.g., TV, monitor, projector, etc.) as you adjust the time lag.

Note:

- The Lip.Sync mode is set to "OFF" (0 ms) in the Pure Direct and Source Direct mode. When the Pure Direct (or Source Direct) mode is deactivated, the previously set value of the Lip. Sync mode is automatically restored.

SURROUND MODE

SURROUND

The SR9600 is equipped with many surround modes. These are provided to reproduce a variety of surround sound effects, according to the content of the source to be played.

The available surround modes may be restricted depending on the input signal and speaker setup.

SOURCE DIRECT

In the Source Direct mode, the tone control circuit and bass management configuration are bypassed for full-range frequency response and the purist audio reproduction.

Notes:

- Speaker size is set to Front L/R = LARGE, Center = LARGE, Surround L/R = LARGE and Subwoofer = YES automatically. Tone controls, equalizer and additional processing are deactivated.
- When you use this mode with certain DVD and CD players, performing operations such as skip or stop may momentarily interrupt the output.

PURE DIRECT

The Pure Direct mode further reduces sources of noise in addition to effect of the Source Direct mode, by blocking output from the video jacks (VIDEO, S-VIDEO, COMPONENT VIDEO and HDMI) and turning the FL display off.

AUTO

When this mode is selected, the SR9600 determines whether the digital input signal is Dolby Digital, Dolby Digital Surround EX, DTS, DTS-ES, DTS 96/24 or PCM audio.

Surround EX & DTS-ES will operate for multichannel sources that have a Dolby Digital Surround EX or DTS-ES auto trigger flag in the digital signal.

When a Dolby Digital or DTS signal is input, the number of channels for which the corresponding signal is encoded will be played.

Inputting a Dolby Digital two channel signal with Dolby surround status automatically subjects that signal to Pro Logic IIx movie processing before play.

PCM 96 kHz source material can be played in this mode.

Notes:

- When you use this mode with certain DVD and CD players, performing operations such as skip or stop may momentarily interrupt the output.
- When the signal is not decoded, the mode is changed to AUTO mode automatically. See page 53 to confirm the available decoding modes.

THX CINEMA

THX Cinema mode applies additional processing to Dolby Digital, DTS and Dolby Pro Logic multichannel, surround sources. The THX processing was developed by Lucasfilm Ltd. to recreate the sound of top-quality theater.

Use the THX Cinema mode for all movies on disc, tape or broadcast. In this mode, the THX Surround EX mode is not available.

THX SURROUND EX

In a movie theater, film soundtracks that have been encoded with Dolby Digital Surround EX technology are able to reproduce an extra channel which has been added during the mixing of the program.

This channel, called Surround Back, places sounds behind the listener in addition to the currently available front left, front center, front right, surround right, surround left and subwoofer channels.

This additional channel provides the opportunity for more detailed imaging behind the listener and brings more depth, spacious ambience and sound localization than ever before.

THX Surround EX will operate for any 5.1 channel source whenever THX is active.

THX Surround EX is not available in system without surround back speaker(s).

Note:

- When playing Dolby Digital Surround EX-encoded software in 6.1 channels, it is required to select the THX Surround EX mode.

THX ULTRA2 CINEMA

THX Ultra2 Cinema mode plays 5.1 movies using all 7.1 speakers giving you the best possible movie watching experience. In this mode, ASA processing blends the surround L/R speakers and surround back speakers, providing the optimal mix of ambient and directional surround sound.

This mode permits the playback of a non Surround EX/ES-encoded 5.1 movie over a 7.1 system.

DTS-ES (Matrix and 6.1 Discrete) and Dolby Digital Surround EX-encoded soundtracks will be automatically detected, if the appropriate flag has been encoded.

Some Dolby Digital Surround EX soundtracks are missing the digital flag that allows automatic switching.

If you know that the movie that you are watching is encoded in Surround EX, you can manually select the THX Surround EX playback mode, otherwise the THX Ultra2 Cinema mode will apply ASA processing to provide optimum replay.

THX MUSIC

For the replay of multichannel music, the THX Music mode should be selected. In this mode, THX ASA processing is applied to the surround channels of all 5.1-encoded music sources, such as DTS and Dolby Digital, to provide a wide, stable, rear soundstage.

This mode is to be used with multichannel music sources such as DTS 5.1 music and Dolby Digital 5.1 music.

Notes:

- These modes are only available when you have setup SPEAKER SIZE menu system (i.e. 2 surround back speakers).
- These modes are only available when the input signal has surround left and surround right contents.

THX GAMES

For the replay of stereo and multichannel game audio the THX Games mode should be selected. In this mode, THX ASA processing is applied to the surround channels of all 5.1 and 2.0-encoded game sources such as analog, PCM, DTS and Dolby Digital. This accurately places all game audio surround information, providing a full 360-degree playback environment. THX Games mode is unique as it gives you a smooth transition of audio in all points of the surround field.

DOLBY DIGITAL

(Dolby Digital, Pro Logic IIx MOVIE, Pro Logic IIx MUSIC, Pro Logic IIx GAME)

This mode is used with source materials encoded in Dolby Digital and Dolby Surround.

DOLBY DIGITAL

This mode is enabled when playing source materials encoded in Dolby Digital.

Playing multichannel-encoded 5.1 channel Dolby Digital sources provides 5 main audio channels (left, center, right, surround left and surround right) and a Low Frequency Effect channel.

Dolby Digital EX decoding is not available in this mode.

Dolby Pro Logic IIx has 5 modes:

Pro Logic IIx MOVIE

This mode provides 6.1 or 7.1 channel surround sound from Dolby Surround, encoded stereo movie soundtracks.

Pro Logic IIx MUSIC

This mode provides 6.1 or 7.1 channel surround sound from conventional stereo sources (analog or digital), such as CD, tape, FM, TV, stereo VCR, etc.

Pro Logic IIx GAME

This mode restores the impact low-frequency surround effects by routing them to the system's subwoofer.

5.1ch + Pro Logic IIx Movie

This mode provides 7.1 channel surround sound from 5.1 channel sources movie soundtracks.

5.1ch + Pro Logic IIx Music

This mode provides 6.1 or 7.1 channel surround sound from 5.1 channel sources music soundtracks.

Notes:

- Pro Logic IIx mode will decode as Pro Logic II mode when the SURR. B is set to "NONE" from SPEAKER SETUP menu. (See page 37)
- Pro Logic IIx mode is available for a 2 channel input signal which is encoded in Dolby Digital, HDCD or PCM format.
- PCM audio signals can be subjected to Pro Logic IIx processing when the sampling frequency is 32 kHz, 44.1 kHz or 48 kHz.

EX/ES

This mode provides 6.1 channel surround for Dolby Digital EX, and DTS-ES-encoded source material such as DVD.

This mode cannot be used when an analog input has been selected.

Dolby Digital EX

In a movie theater, film soundtracks that have been encoded with Dolby Digital Surround EX technology are able to reproduce an extra channel which has been added during the mixing of the program.

This channel, called surround back, places sounds behind the listener in addition to the currently available front left, front center, front right, surround right, surround left and subwoofer channels.

This additional channel provides the opportunity for more detailed imaging behind the listener and brings more depth, spacious ambience and sound localization than ever before.

Dolby Digital EX is not available in systems that do not have without surround back speaker(s).

DTS-ES (Discrete 6.1, Matrix 6.1)

DTS-ES adds the surround center channel audio to the DTS 5.1 channel format to improve the acoustic positioning, and makes acoustic image movement more natural with the 6.1 channel reproduction.

The SR9600 incorporates a DTS-ES-decoder, which can handle DTS-ES Discrete-encoded and DTS-ES Matrix-encoded program sources from DVD, etc.

DTS-ES Discrete 6.1 features digital discrete recording of all channels, including the surround back channel(s), and higher quality audio reproduction.

DTS-ES is not available in systems that do not have surround back speakers.

dts**dts, Neo:6 Cinema, Neo:6 Music**

This mode is for DTS-encoded source materials such as laserdisc, CD and DVD. Neo:6 is for some 2 channel sources.

dts

This mode is enabled when playing source materials encoded in dts multichannel.

Playing multichannel encoded-5.1 channel dts sources provides five main audio channels (left, center, right, surround left and surround right) and a Low Frequency Effects channel.

dts-ES decoding is not available in this mode.

The DTS mode cannot be used when an analog input has been selected.

Neo:6 Cinema, Neo:6 Music

This mode decodes 2 channel signals into 6 channel signals using high-accuracy digital matrix technology.

The DTS Neo:6 decoder has near-discrete properties in the frequency characteristics of the channels as well as in channel separation.

According to the signals to be played back, DTS Neo:6 uses either the Neo:6 Cinema mode optimized for movie playback or the Neo:6 Music mode optimized for music playback.

Notes:

- The Neo:6 mode is available for 2 channel input signals which are encoded in Dolby Digital, HDCD or PCM format.
- PCM audio signals can be subjected to Neo:6 processing when the sampling frequency is 32 kHz, 44.1 kHz or 48 kHz.

MULTI CH. ST

This mode is used to create a wider, deeper and more natural soundstage from two channel source material. This is done by feeding the left channel signal to both the left front and left surround speakers and the right channel signal to both the right front and right surround speakers. Additionally, the center channel reproduces a mix of the right and left channels.

**CIRCLE SURROUND II
(CSII-CINEMA, CSII-MUSIC, CSII-MONO)**

Circle Surround is designed to enable multichannel surround sound playback of non-encoded and multichannel encoded material.

Backward compatibility provides listeners with up to 6.1 channels of surround performance from an entire collection of music and film, including broadcast, videotape and stereo recorded music. Depending on source material, you can select CSII-Cinema mode, CSII-Music mode or CSII-Mono mode.

Notes:

- The CS II mode is available for 2 channel input signals which are encoded in Dolby Digital, HDCD or PCM format.
- PCM audio signals can be subjected to CS II processing when the sampling frequency is 32 kHz, 44.1 kHz or 48 kHz.

VIRTUAL

This mode creates a virtualized surround sound experience from a two-speaker (front L and R) playback system playing any multichannel audio source (such as found on DVDs and digital broadcasts), including Dolby Digital, Dolby Pro Logic or DTS.

STEREO

This mode bypasses all surround processing.

In stereo program sources, the left and right channels play normally when PCM audio or analog stereo is input.

With Dolby Digital and DTS sources, the 5.1 channels are converted to two channel stereo. 96 kHz PCM source material can be played back in stereo mode.

CAUTION**Note for DTS**

- To connected DVD player, laserdisc player or CD player needs to support DTS digital output. You may not be able to play some DTS source signals from certain CD players and LD players even if you connect the player to the SR9600 digitally. This is because the digital signal has been processed (such as the output level, sampling frequency or frequency response), and the SR9600 cannot recognize the signal as DTS data.
- Depending on the player used, DTS play may produce a short noise. This is not a malfunction.
- While signals from a DTS laserdisc or CD are playing in another surround mode, you cannot switch to digital input or from digital input to analog input from the INPUT SETUP in the MAIN MENU or by pressing the **A/D** button.
- You can not listen to DTS-encoded software in a multiroom.
- The outputs for VCR 1 OUT, DSS/VCR 2 OUT, TAPE OUT and CD-R OUT output analog audio signals only. Do not record from CDs or LDs that support DTS using these outputs. If you do, the DTS-encoded signal will be recorded as noise.

Note or Dolby Digital Surround EX

- When playing Dolby Digital Surround EX-encoded software in 6.1 channels, it is required to set the EX/ES mode.
- Note that some Dolby Digital Surround EX-encoded software does not contain the identification signal. In this case, set the EX/ES mode manually.

Note for 96 kHz/192 kHz PCM audio

- The AUTO, Pure Direct, and Stereo modes can be used when playing PCM signals with a sampling frequency of 96/192 kHz (such as from DVD-Video/Audio discs).
- Certain DVD player models inhibit digital output. For details, refer to the player's operation manual.
- Some DVD discs feature copy protection. When using such disc, 96 kHz PCM signal are not output from the DVD player. For details, refer to the player's operation manual.

Note for HDCD

- HDCD is effective only through digital input.
- You may not be able to play some HDCD source signals from certain CD players if you connect the player to the SR9600 digitally. This is because the digital signal has been processed (such as the output level, sampling frequency or frequency response) and the SR9600 cannot recognize the signal as HDCD data.

The relationship between the selected surround mode and the input signal

The surround mode is selected with the surround mode selector on the SR9600 or the remote control unit. However, the sound you hear is subject to the relationship between the selected surround mode and the input signal. That relationship is as follows:

Surround Mode	Input Signal	Decoding	Output Channel					Front Information Display		
			L/R	C	SL SR	SBL SBR	SubW	Signal Format Indicators	Channel Status	
AUTO	Dolby Surr.EX	Dolby Digital EX	○	○	○	○	○	DD DIGITAL EX	L, C, R, SL, SR, S, LFE	
	Dolby D (5.1ch)	Dolby Digital 5.1	○	○	○	-	○	DD DIGITAL	L, C, R, SL, SR, LFE	
	Dolby D (2ch)	Dolby Digital 2.0	○	-	-	-	○	DD DIGITAL	L, R	
	Dolby D (2ch Surr)	Pro Logic IIx movie	○	○	○	○	○	DD DIGITAL DD SURROUND	L, R, S	
	DTS-ES	DTS-ES	○	○	○	○	○	ds, ES	L, C, R, SL, SR, S, LFE	
	DTS 96/24	DTS-96/24	○	○	○	-	○	ds 96/24	L, C, R, SL, SR, LFE	
	DTS (5.1ch)	DTS 5.1	○	○	○	-	○	ds	L, C, R, SL, SR, LFE	
	Multi Ch-PCM	Multi Ch-PCM	○	○	○	-	○	M-PCM	L, C, R, SL, SR, LFE	
	Multi Ch-PCM 96kHz	Multi Ch-PCM 96kHz	○	○	○	-	○	M-PCM	L, C, R, SL, SR, LFE	
	SA-CD (5.1ch)	Multi Ch-PCM	○	○	○	-	○	SA-CD	L, C, R, SL, SR, LFE	
	SA-CD (2ch)	PCM (Stereo)	○	-	-	-	○	SA-CD	L, R	
	PCM (Audio)	PCM (Stereo)	○	-	-	-	○	PCM	L, R	
	PCM 96kHz	PCM (Stereo 96kHz)	○	-	-	-	○	PCM	L, R	
	HDCCD	HDCCD	○	-	-	-	○	PCM, HDCCD	L, R	
	Analog	Stereo	○	-	-	-	○	ANALOG	-	
	7.1ch input	Multi Ch	○	○	○	○	○	ANALOG	-	
	SOURCE DIRECT PURE DIRECT	Dolby Surr.EX	Dolby Digital EX	○	○	○	○	○	DD DIGITAL EX	L, C, R, SL, SR, S, LFE
		Dolby D (5.1ch)	Dolby Digital 5.1	○	○	○	-	○	DD DIGITAL	L, C, R, SL, SR, LFE
		Dolby D (2ch)	Dolby Digital 2.0	○	-	-	-	○	DD DIGITAL	L, R
Dolby D (2ch Surr)		Pro Logic IIx movie	○	○	○	○	○	DD DIGITAL DD SURROUND	L, R, S	
DTS-ES		DTS-ES	○	○	○	○	○	ds, ES	L, C, R, SL, SR, S, LFE	
DTS 96/24		DTS-96/24	○	○	○	-	○	ds 96/24	L, C, R, SL, SR, LFE	
DTS (5.1ch)		DTS 5.1	○	○	○	-	○	ds	L, C, R, SL, SR, LFE	
Multi Ch-PCM		Multi Ch-PCM	○	○	○	-	○	M-PCM	L, C, R, SL, SR, LFE	
Multi Ch-PCM 96kHz		Multi Ch-PCM 96kHz	○	○	○	-	○	M-PCM	L, C, R, SL, SR, LFE	
SA-CD (5.1ch)		SA-CD (5.1ch)	○	○	○	-	○	SA-CD	L, C, R, SL, SR, LFE	
SA-CD (2ch)		SA-CD (2ch)	○	-	-	-	○	SA-CD	L, R	
PCM (Audio)		PCM (Stereo)	○	-	-	-	○	PCM	L, R	
PCM 96kHz		PCM (Stereo 96kHz)	○	-	-	-	○	PCM	L, R	
HDCCD		HDCCD	○	-	-	-	○	PCM, HDCCD	L, R	
Analog		Stereo	○	-	-	-	○	ANALOG	-	
7.1ch input		Multi Ch	○	○	○	○	○	ANALOG	-	
EX/ES		Dolby Surr.EX	Dolby Digital EX	○	○	○	○	○	DD DIGITAL EX	L, C, R, SL, SR, S, LFE
		Dolby D (5.1ch)	Dolby Digital EX	○	○	○	○	○	DD DIGITAL	L, C, R, SL, SR, LFE
		DTS-ES	DTS-ES	○	○	○	○	○	ds, ES	L, C, R, SL, SR, S, LFE
	DTS (5.1ch)	DTS-ES	○	○	○	○	○	ds	L, C, R, SL, SR, LFE	
	Multi-PCM	Multi Ch-PCM + Dolby EX	○	○	○	○	○	M-PCM	L, C, R, SL, SR, LFE	
	SA-CD (5.1ch)	Multi Ch-PCM + Dolby EX	○	○	○	○	○	SA-CD	L, C, R, SL, SR, LFE	
	7.1ch input	Multi Ch	○	○	○	○	○	ANALOG	-	
DOLBY (PLIIX movie) (PLIIX music) (PLIIX game)	Dolby Surr.EX	Dolby Digital 5.1	○	○	○	-	○	DD DIGITAL EX	L, C, R, SL, SR, S, LFE	
	Dolby D (5.1ch)	Dolby Digital 5.1	○	○	○	-	○	DD DIGITAL	L, C, R, SL, SR, LFE	
	Dolby D (5.1ch)	Dolby Digital 5.1 + PLIIX	○	○	○	○	○	DD DIGITAL	L, C, R, SL, SR, LFE	
	Dolby D (2ch)	Pro Logic IIx	○	○	○	○	○	DD DIGITAL	L, R	
	Dolby D (2ch Surr)	Pro Logic IIx	○	○	○	○	○	DD DIGITAL DD SURROUND	L, R, S	
	Multi Ch-PCM	Multi Ch-PCM + PLIIX	○	○	○	○	○	M-PCM	L, C, R, SL, SR, LFE	
	SA-CD (5.1ch)	Multi Ch-PCM + PLIIX	○	○	○	○	○	SA-CD	L, C, R, SL, SR, LFE	
	SA-CD (2ch)	Pro Logic IIx	○	○	○	○	○	SA-CD	L, R	
	PCM (Audio)	Pro Logic IIx	○	○	○	○	○	PCM	L, R	
	HDCCD	Pro Logic IIx	○	○	○	○	○	PCM, HDCCD	L, R	
	Analog	Pro Logic IIx	○	○	○	○	○	ANALOG	-	
7.1ch input	Multi Ch-PCM + PLIIX	○	○	○	○	○	ANALOG	-		
DTS (Neo:6 Cinema) (Neo:6 Music)	DTS-ES	DTS 5.1	○	○	○	-	○	ds, ES	L, C, R, SL, SR, S, LFE	
	DTS 96/24	DTS-96/24	○	○	○	-	○	ds 96/24	L, C, R, SL, SR, LFE	
	DTS (5.1ch)	DTS 5.1	○	○	○	-	○	ds	L, C, R, SL, SR, LFE	
	Dolby D (2ch)	Neo:6	○	○	○	○	○	DD DIGITAL	L, R	
	Dolby D (2ch Surr)	Neo:6	○	○	○	○	○	DD DIGITAL DD SURROUND	L, R, S	
	SA-CD (2ch)	Neo:6	○	○	○	○	○	SA-CD	L, R	
	PCM(Audio)	Neo:6	○	○	○	○	○	PCM	L, R	
	HDCCD	Neo:6	○	○	○	○	○	PCM, HDCCD	L, R	
	Analog	Neo:6	○	○	○	○	○	ANALOG	-	
	7.1ch input	Multi Ch-PCM + PLIIX	○	○	○	○	○	ANALOG	-	
CSII Cinema CSII Music CSII Mono	Dolby D (2ch)	CSII	○	○	○	○	○	DD DIGITAL	L, R	
	Dolby D (2ch Surr)	CSII	○	○	○	○	○	DD DIGITAL DD SURROUND	L, R, S	
	SA-CD (2ch)	CSII	○	○	○	○	○	SA-CD	L, R	
	PCM(Audio)	CSII	○	○	○	○	○	PCM	L, R	
	HDCCD	CSII	○	○	○	○	○	PCM, HDCCD	L, R	
	Analog	CSII	○	○	○	○	○	ANALOG	-	
STEREO	Dolby Surr.EX	Stereo	○	-	-	-	○	DD DIGITAL EX	L, C, R, SL, SR, S, LFE	
	Dolby D (5.1ch)	Stereo	○	-	-	-	○	DD DIGITAL	L, C, R, SL, SR, LFE	
	Dolby D (2ch)	Stereo	○	-	-	-	○	DD DIGITAL	L, R	
	Dolby D (2ch Surr)	Stereo	○	-	-	-	○	DD DIGITAL DD SURROUND	L, R, S	
	DTS-ES	Stereo	○	-	-	-	○	ds, ES	L, C, R, SL, SR, S, LFE	
	DTS 96/24	Stereo	○	-	-	-	○	ds 96/24	L, C, R, SL, SR, LFE	
	DTS (5.1ch)	Stereo	○	-	-	-	○	ds	L, C, R, SL, SR, LFE	
	Multi Ch-PCM	Stereo	○	-	-	-	○	M-PCM	L, C, R, SL, SR, LFE	
	Multi Ch-PCM 96kHz	Stereo	○	-	-	-	○	M-PCM	L, C, R, SL, SR, LFE	
	SA-CD (5.1ch)	Stereo	○	-	-	-	○	SA-CD	L, C, R, SL, SR, LFE	
	SA-CD (2ch)	Stereo	○	-	-	-	○	SA-CD	L, R	
	PCM (Audio)	Stereo	○	-	-	-	○	PCM	L, R	
	PCM 96kHz	Stereo	○	-	-	-	○	PCM	L, R	
	HDCCD	Stereo	○	-	-	-	○	PCM, HDCCD	L, R	
	Analog	Stereo	○	-	-	-	○	ANALOG	-	

Surround Mode	Input Signal	Decoding	Output Channel					Front Information Display	
			L/R	C	SL SR	SBL SBR	SubW	Signal Format Indicators	Channel Status
Virtual	Dolby Surr.EX	Virtual	○	-	-	-	-	DD DIGITAL EX	L, C, R, SL, SR, S, LFE
	Dolby D (5.1ch)	Virtual	○	-	-	-	-	DD DIGITAL	L, C, R, SL, SR, LFE
	Dolby D (2ch)	Virtual	○	-	-	-	-	DD DIGITAL	L, R
	Dolby D (2ch Surr)	Virtual	○	-	-	-	-	DD DIGITAL DD SURROUND	L, R, S
	DTS-ES	Virtual	○	-	-	-	-	dtc, ES	L, C, R, SL, SR, S, LFE
	DTS 96/24	Virtual	○	-	-	-	-	dtc 96/24	L, C, R, SL, SR, LFE
	DTS (5.1ch)	Virtual	○	-	-	-	-	dtc	L, C, R, SL, SR, LFE
	Multi Ch-PCM	Virtual	○	-	-	-	-	M-PCM	L, C, R, SL, SR, LFE
	SA-CD (5.1ch)	Virtual	○	-	-	-	-	SA-CD	L, C, R, SL, SR, LFE
	SA-CD (2ch)	Virtual	○	-	-	-	-	SA-CD	L, R
	PCM (Audio)	Virtual	○	-	-	-	-	PCM	L, R
	HDCD	Virtual	○	-	-	-	-	PCM, HDCD	L, R
	Analog	Virtual	○	-	-	-	-	ANALOG	-
Multi Ch. Stereo	Dolby Surr.EX	Dolby Digital EX	○	○	○	○	○	DD DIGITAL EX	L, C, R, SL, SR, S, LFE
	Dolby D (5.1ch)	Dolby Digital 5.1	○	○	○	-	○	DD DIGITAL	L, C, R, SL, SR, LFE
	Dolby D (2ch)	Multi Channel Stereo	○	○	○	○	○	DD DIGITAL	L, R
	Dolby D (2ch Surr)	Multi Channel Stereo	○	○	○	○	○	DD DIGITAL DD SURROUND	L, R, S
	DTS-ES	DTS-ES	○	○	○	○	○	dtc, ES	L, C, R, SL, SR, S, LFE
	DTS 96/24	DTS-96/24	○	○	○	-	○	dtc 96/24	L, C, R, SL, SR, LFE
	DTS (5.1ch)	DTS 5.1	○	○	○	-	○	dtc	L, C, R, SL, SR, LFE
	Multi Ch-PCM	Multi Ch-PCM	○	○	○	-	○	M-PCM	L, C, R, SL, SR, LFE
	Multi Ch-PCM 96kHz	Multi Ch-PCM 96kHz	○	○	○	-	○	M-PCM	L, C, R, SL, SR, LFE
	SA-CD (5.1ch)	Multi Ch-PCM	○	○	○	-	○	SA-CD	L, C, R, SL, SR, LFE
	SA-CD (2ch)	Multi Channel Stereo	○	○	○	-	○	SA-CD	L, R
	PCM (Audio)	Multi Channel Stereo	○	○	○	-	○	PCM	L, R
	HDCD	Multi Channel Stereo	○	○	○	-	○	PCM, HDCD	L, R
Analog	Multi Channel Stereo	○	○	○	-	○	ANALOG	-	
Dolby H.P	Dolby Surr.EX	Dolby H.P	○	-	-	-	-	DD DIGITAL EX	L, C, R, SL, SR, S, LFE
	Dolby D (5.1ch)	Dolby H.P	○	-	-	-	-	DD DIGITAL	L, C, R, SL, SR, LFE
	Dolby D (2ch)	Dolby H.P	○	-	-	-	-	DD DIGITAL	L, R
	Dolby D (2ch Surr)	Dolby H.P	○	-	-	-	-	DD DIGITAL DD SURROUND	L, R, S
	DTS-ES	Dolby H.P	○	-	-	-	-	dtc, ES	L, C, R, SL, SR, S, LFE
	DTS 96/24	Dolby H.P	○	-	-	-	-	dtc 96/24	L, C, R, SL, SR, LFE
	DTS (5.1ch)	Dolby H.P	○	-	-	-	-	dtc	L, C, R, SL, SR, LFE
	Multi Ch-PCM	Dolby H.P	○	-	-	-	-	M-PCM	L, C, R, SL, SR, LFE
	SA-CD (5.1ch)	Dolby H.P	○	-	-	-	-	SA-CD	L, C, R, SL, SR, LFE
	SA-CD (2ch)	Dolby H.P	○	-	-	-	-	SA-CD	L, R
	PCM (Audio)	Dolby H.P	○	-	-	-	-	PCM	L, R
	HDCD	Dolby H.P	○	-	-	-	-	PCM, HDCD	L, R
	Analog	Dolby H.P	○	-	-	-	-	ANALOG	-
THX (THX Games)	Dolby Surr.EX	Dolby Digital + THX Surround EX	○	○	○	○	○	DD DIGITAL EX	L, C, R, SL, SR, S, LFE
	Dolby D (5.1ch)	Dolby Digital 5.1+ THX 5.1	○	○	○	-	○	DD DIGITAL	L, C, R, SL, SR, LFE
	Dolby D (2ch)	Pro Logic IIx movie + THX	○	○	○	○	○	DD DIGITAL	L, R
	Dolby D (2ch Surr)	Pro Logic IIx movie + THX	○	○	○	○	○	DD DIGITAL DD SURROUND	L, R, S
	DTS-ES	DTS-ES + THX	○	○	○	○	○	dtc, ES	L, C, R, SL, SR, S, LFE
	DTS (5.1ch)	DTS + THX 5.1	○	○	○	-	○	dtc	L, C, R, SL, SR, LFE
	Multi Ch-PCM	Multi Ch-PCM + THX5.1	○	○	○	-	○	M-PCM	L, C, R, SL, SR, LFE
	SA-CD (5.1ch)	Multi Ch-PCM + THX5.1	○	○	○	-	○	SA-CD	L, C, R, SL, SR, LFE
	SA-CD (2ch)	Pro Logic IIx movie + THX	○	○	○	-	○	SA-CD	L, R
	PCM (Audio)	Pro Logic IIx movie + THX	○	○	○	-	○	PCM	L, R
	HDCD	Pro Logic IIx movie + THX	○	○	○	-	○	PCM, HDCD	L, R
	Analog	Pro Logic IIx movie + THX	○	○	○	-	○	ANALOG	-
	THX Ultra2 (THX EX) (THX Music) (THX Games)	Dolby Surr.EX	Dolby Digital + THX Surround EX	○	○	○	○	○	DD DIGITAL EX
Dolby D (5.1ch)		Dolby Digital 5.1+ THX Ultra2 Cinema	○	○	○	-	○	DD DIGITAL	L, C, R, SL, SR, LFE
Dolby D (2ch)		Pro Logic IIx movie + THX	○	○	○	○	○	DD DIGITAL	L, R
Dolby D (2ch Surr)		Pro Logic IIx movie + THX	○	○	○	○	○	DD DIGITAL DD SURROUND	L, R, S
DTS-ES		DTS-ES + THX	○	○	○	○	○	dtc, ES	L, C, R, SL, SR, S, LFE
DTS (5.1ch)		DTS + THX Ultra2 Cinema	○	○	○	-	○	dtc	L, C, R, SL, SR, LFE
Multi Ch-PCM		Multi Ch-PCM + THX Ultra2 Cinema	○	○	○	-	○	M-PCM	L, C, R, SL, SR, LFE
SA-CD (5.1ch)		Multi Ch-PCM + THX Ultra2 Cinema	○	○	○	-	○	SA-CD	L, C, R, SL, SR, LFE
SA-CD (2ch)		Pro Logic IIx movie + THX	○	○	○	-	○	SA-CD	L, R
PCM (Audio)		Pro Logic IIx movie + THX	○	○	○	-	○	PCM	L, R
HDCD		Pro Logic IIx movie + THX	○	○	○	-	○	PCM, HDCD	L, R
Analog		Pro Logic IIx movie + THX	○	○	○	-	○	ANALOG	-

Notes:

- Dolby Digital (2 channel L/R): Speakers for signal with Dolby Surround are fully equipped.
- No sound is outputs from the surround speaker, center speaker and subwoofer if the DVD disc has no surround data.

Abbreviations

- L/R : Front speakers
- C : Center speaker
- SL/SR : Surround speakers
- SBL/SBR : Surround back speakers
- SubW : Subwoofer

OTHER FUNCTION

The remote control operations in this chapter are performed with the remote control unit set to the Amp mode. To set the Amp mode, tap the **A/V Amp** on the Home screen on the remote control unit.

VIDEO AUTO ON/OFF FUNCTION

This function allows the component connected to the VIDEO input jack to control the power (ON/OFF) to the SR9600.

The Auto Power On/Off mode is explained using a connected DVD player as an example.

AUTO POWER ON

1. Connect a DVD player to the DVD VIDEO, S-VIDEO or COMPONENT VIDEO input jack.
2. Be sure the Video on mode in the SETUP MENU is set to "ENABLED". (See page 43 : 4. VIDEO SETUP) Turn on the DVD player.

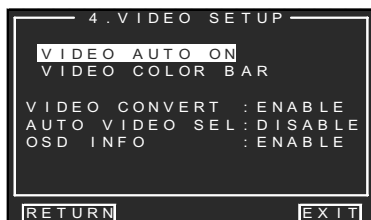

3. Turn off the power to the DVD player and the SR9600.
4. Turn on the DVD player.
5. The SR9600 turns on and DVD player is selected automatically.

AUTO POWER OFF

1. Turn the DVD player off.
2. The power to the SR9600 switches to standby after approx. 5 minutes.

Notes:

- The Auto Power Off mode is canceled if the SR9600 is set to a source other than DVD.
- Some progressive video signals cannot be detected when input to the COMPONENT VIDEO input jacks.

AUTO VIDEO SELECTOR (AUTO VIDEO SEL)

Function can be changed according to the detected video signal.

1. Be sure the AUTO VIDEO SEL mode in the SETUP MENU is set to "ENABLED". (See page 43 : 4. VIDEO SETUP)

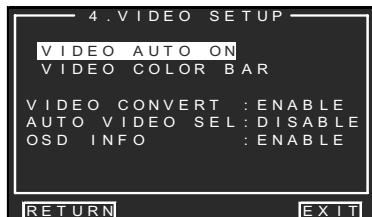

2. Turn on the power, for example, to the DVD player.
3. The DVD Function is automatically selected.

Notes:

- If a separate video signal (e.g., DSS, etc.) is input after another component has been automatically selected, the receiver switches to the DSS mode. Then, when that DSS signal ceases, the receiver searches for a component that is inputting a video signal and switches to it.
- This feature works with the VIDEO, S-VIDEO and COMPONENT VIDEO input jacks.
- Some progressive video signals cannot be detected when input to the COMPONENT VIDEO input jacks.

ATTENUATION TO ANALOG INPUT SIGNAL

If the selected analog audio input signal is greater than the capable level of internal processing, the "PEAK" indicator will light up on the front display.

1. If this happens, you should tap the **ATT** on the remote control unit.

The "ATT" indicator is illuminated when this function is activated. The signal input level is reduced by about half.

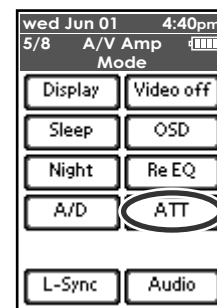

2. To turn the attenuation feature off, tap the **ATT** on the remote control unit again.

Notes:

- Attenuation will not work with the output signal from TAPE OUT, CD-R/MD OUT, VCR1 OUT and VCR2/DVD-R OUT.
- This function is memorized for each individual input source.

LISTENING THROUGH HEADPHONES

This jack may be used to listen to the SR9600's output through a pair of headphones. Be certain that the headphones have a standard 1/4" stereo phono plug. (Note that the speakers will automatically be turned off when the headphone jack is in use.)

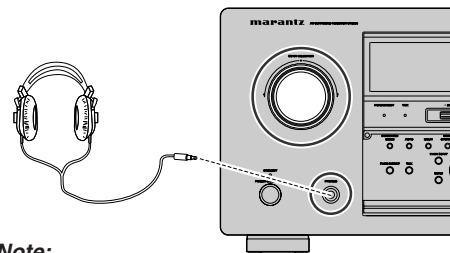

Note:

- The surround mode returns to the previous setting as soon as the plug is removed from the jack.

DOLBY HEADPHONE MODE

This feature simulates the waveforms of the actual sounds heard from the speakers.

When headphones are used, the **MENU** button automatically switches to the Dolby headphone mode.

The OSD menu system that appears when the **MENU** button is pressed is shown below.

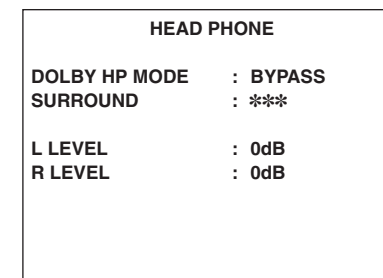

Select the desired DOLBY HP (Headphone) mode with the ◀ or ▶ cursor buttons.

BYPASS → **DH1** → **DH2** → **DH3** → **BYPASS**

BYPASS: Bypasses the Dolby headphone mode and delivers ordinary 2 channel stereo.

DH1: The size of a typical living room space is simulated.

DH2: The expansiveness of a structure as large as a music hall is simulated.

DH3: A large space such as that found in a movie theater is simulated.

When the Pure Direct or Source Direct mode is selected, Dolby surround processing is bypassed and "***" is displayed as the mode indication.

Surround mode can be selected when DH1, DH2 or DH3 is selected.

The L/R level can be set in the ±10 dB range.

Notes:

- The surround mode returns to the previous setting as soon as the plug is removed from the jack.
- The TONE cannot be set when DH1, DH2 or DH3 is selected.
- The Dolby Headphone mode will not work when 96/192 kHz PCM digital signals are input.

VIDEO ON/OFF

When no video signal is connected to the SR9600 or a DVD, etc., is connected directly to your TV, the unnecessary video circuit can be turned off by setting the video off mode.

- To set the video off mode, tap the **A/V Amp** and press the **page up** button until page 5/8 is displayed. Tap the **Video off** on the remote control unit. "V-OFF" indicator will be illuminated when this function is activated.

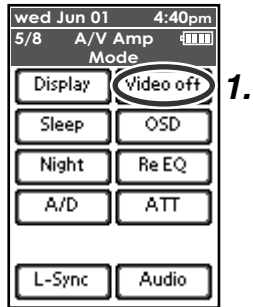

- To cancel the Video Off mode, tap the **Video off** on the remote control unit again.

DISPLAY MODE

You can select the display mode for the front panel display on the SR9600.

- To select this mode, press the **DISPLAY** button on the front panel or tap the **Display** on the remote control.

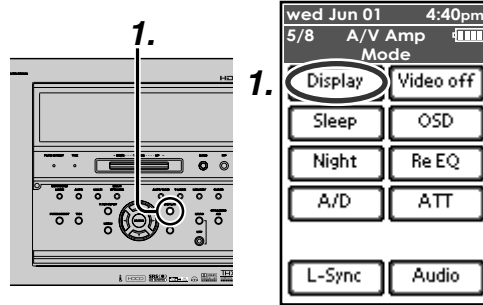

When this button is pressed, the Display mode is switched in the following sequence:

Normal mode → **Level Meter mode** → **Auto Display Off mode** → **Display Off mode** → **Normal mode** →

Normal mode:

Displays the selected component.

Level meter mode:

Displays the current output level of up to 7.1 channels as a bar graph.

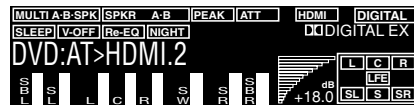

Auto Display Off mode:

The display is off. But, if you make a change to the unit such as the input or surround mode, the display will show that change, then go back to off after about 3 seconds. When changing the volume, it is not displayed.

Display Off mode:

The display is off completely.

Note:

- Only the "DISP" indicator will be illuminated on the front panel display when the Display Off mode is selected.
- Only SBL is displayed in the Level Meter mode if "SURR.B" on the SPEAKER SIZE menu in the SETUP MENU is set to 1 channel (1CH).

SELECTING ANALOG AUDIO INPUT OR DIGITAL AUDIO INPUT

If you have already assigned the digital inputs, you can temporarily select the audio input mode for each input source.

- Tap the **A/V Amp** and press the **page up** button until page 5/8 is displayed. Tap the **A/D** on the remote control unit.

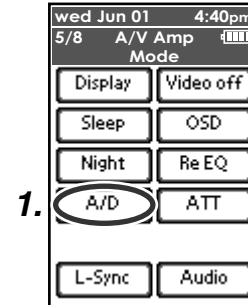

When the **A/D** is tapped, the input mode is switched in the following sequence:

Auto → **i.LINK** → **HDMI** → **Digital** → **Analog** → **Auto**

Auto mode:

The types of signals being input to the digital and analog input jacks for the selected input source are detected automatically. If no digital signal is being input, the analog input jacks are selected automatically.

i.LINK mode:

i.LINK mode can be selected only when an i.LINK device has been assigned as an input source.

HDMI mode:

HDMI mode can be selected only when an HDMI input has been assigned as an input source.

Digital mode:

The input signal is fixed to an assigned digital input terminal.

Analog mode:

The analog input jacks are selected.

This selection is temporary and will not be stored in memory.

To store changes to the input mode, select "1. **INPUT SETUP**" from the MAIN MENU. (See page 32)

RECORDING AN ANALOG SOURCE

In normal operation, the audio or video source selected for listening through the SR9600 is sent to the record outputs.

This means that any program you are watching or listening to may be recorded simply by placing machines connected to the outputs for TAPE OUT, CD-R/MD OUT, VCR1 OUT, and VCR2/DVD-R OUT in the Record mode.

To record the input source signal you are currently watching or listening to

- Select the input source to record by turning the **INPUT SELECTOR** knob on the front panel or simply select a source from among the **Source Select** screen on page 1/8 on the remote control unit.

The input source is now selected and you may watch or listen to it as desired.

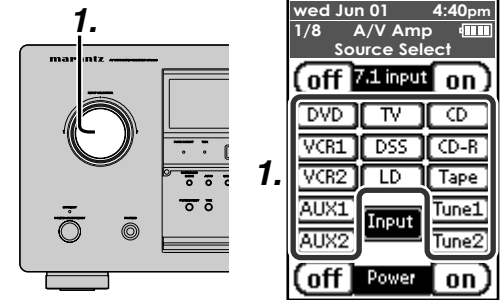

- The currently selected input source signal is output to TAPE OUT, CD-R/MD OUT, VCR1 OUT, and VCR2/DVD-R OUT for recording.
- Start recording to the recording component as desired.

Recording the video from one source and the audio from another

You can add the sound from one source to the video of another source to make your own video recordings.

Below is an example of recording the sound from a compact disc player connected to CD IN and the video from a video camera connected to VCR1 to video cassette recorder connected to the VCR2/DVD-R OUT jack.

1. Switch the video input source to VCR1 by tapping the **VCR1** on page 1/8 on the remote control unit.

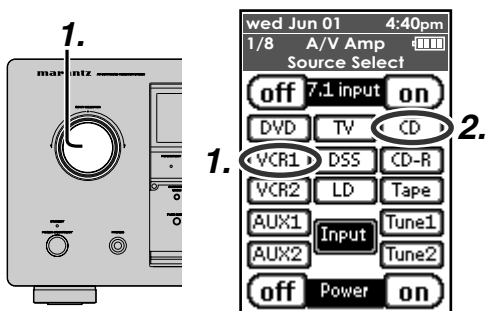

2. Switch the audio input source to CD by tapping the **CD** on page 1/8 on the remote control unit.
3. "CD" is now selected as the audio input source and "VCR1" as the video input source.

Notes:

- If you change the input source during recording, you will record the signals from the newly selected input source.
- You cannot record surround effects.
- Digital input signals are only output to the digital outputs. There is no conversion from digital to analog.

When connecting CD players and other digital components, do not connect only the digital terminals, but the analog ones as well.

7.1 CH INPUT

The SR9600 is equipped for future expansion through support for SACD multichannel or DVD-Audio players.

When this is selected, the input signals connected to the L (front left), R (front right), C (center), SL (surround left), SR (surround right), SBL (surround back left) and SBR (surround back right) channels of the 7.1 CH. In jacks are output directly to the front (left and right), center, surround (left and right) and surround back speaker systems as well as the pre-out jacks without passing through the surround circuitry.

In addition, the signal input to the SW (subwoofer) jack is output to the PRE OUT SW (subwoofer) jack. The video input source for 7.1 channel input is set on the 7.1 CH INPUT SETUP menu. (See page 33) This permits simultaneous viewing with video sources.

1. Press the **7.1 CH INPUT** button on the front panel or tap the **7.1 input on** (page 1/8) on the remote control unit to switch to 7.1 channel input.

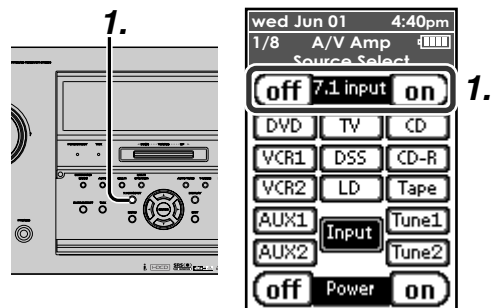

2. If it is necessary to adjust the output level of each channel, tap the **CH Sel** and **Ch Level** (PAGE6/8) on the remote control unit.

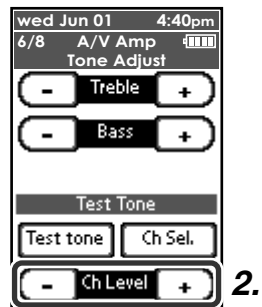

Adjust the speaker output levels so that you can hear the same sound level from each speaker at the listening position. For the front left, front right, center, surround left, surround right and surround back speakers, the output levels can be adjusted between -12 to +12 dB. The subwoofer can be adjusted between -18 and +12 dB.

These adjustments result will be stored to the 7.1 CH. Input memory.

3. Adjust the main volume with the **VOLUME control knob** on the front panel or the **VOL ▲ / ▼** buttons on the remote.

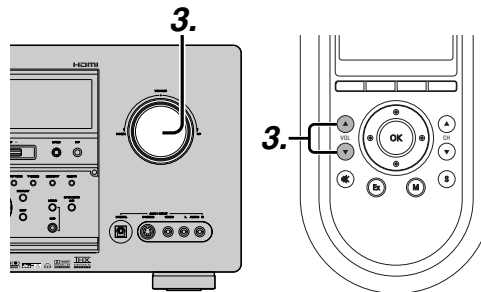

To cancel the 7.1 CH. Input setting, press the **7.1 CH INPUT** button on the front panel or tap the **7.1 input off** on the remote control unit.

Notes:

- When the 7.1 CH. Input mode is activated, you may not select a surround mode, as the external decoder determines processing.
- In addition, there is no signal sent to the record outputs when the 7.1 CH. Input mode is activated.
- The SR9600 has two input modes: 5.1 channel and 7.1 channel. Set the input mode on the 7.1 CH INPUT SETUP menu. (See page 33)

5.1 Channel Input mode:

Surround processing such as for THX music is performed for 5.1 channel input, excluding surround back left and right channels.

7.1 Channel Input mode:

Surround processing is not performed for 7.1 channel analog input.

SPEAKER A/B

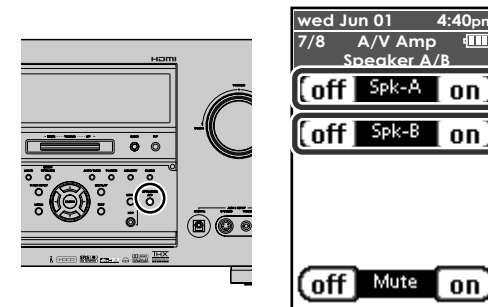

The SR9600 allows you to select speaker system A and speaker system B for the front L/R channels. You can select these systems by pressing the **SPEAKERS A/B** button on the front panel or by tapping **Spk-A on/off** and **Spk-B on/off** (page 7/8) on the remote control unit.

AUX2 INPUT

If you don't need to connect 7.1 channel input terminals for multichannel decoding, the L (front left) and R (front right) input terminals can be used for AUX2 input.

In this case, you can connect additional audio sources to AUX2.

1. To select AUX2, turn the **INPUT SELECTOR** knob on the front panel.

Tap the **A/V Amp** on the remote control unit and press the **page up** button until page 1/8 is displayed. Tap the **AUX2** on the remote control unit.

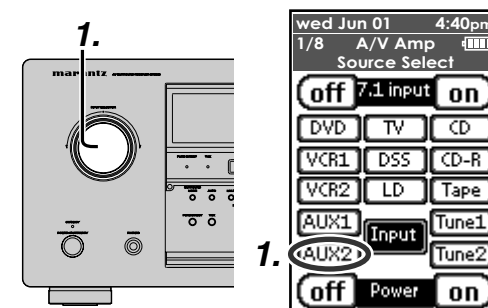

BASIC OPERATION

(TUNER)

This receiver incorporates two tuners with completely independent remote control buttons. Tuner 1 is used in this explanation.

LISTENING TO THE TUNER

The AM frequency scan increments are selectable. The default is 10 kHz increments. If your country's standard is 9 kHz increments, press and hold either the **BAND** button on the front panel or the **AM** button on the remote control unit for 5 sec or more. The new scan increments will be stored.

Note:

- The all Preset memory for the tuner will be cleared clear by changing this setting.

AUTO TUNING

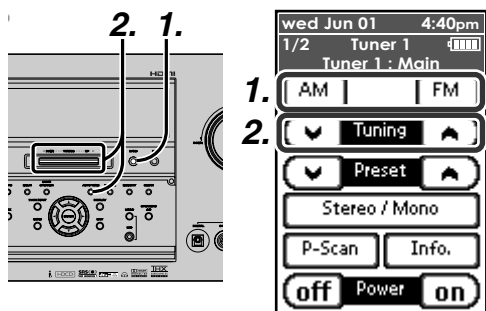

(Using the SR9600)

- To select the tuner and desired band (AM or FM), press the **BAND** button on the front panel.
- Press the **AUTO TUNE** button on the front panel, and turn the **GYRO TUNING** dial to start the Auto Tuning mode.
- Automatic searching begins then stops when a station is tuned in.

(Using the remote control unit)

- To select the tuner and desired band (AM or FM), tap the **AM** or **FM**.
- Tap and hold the Tuning **▲** and **▼** for 1 sec or more.
- Automatic searching begins then stops when a station is tuned in.

If tuning does not stop at the desired station, use manual tuning.

MANUAL TUNING

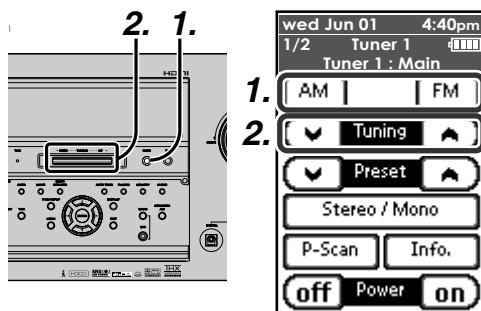

(Using the SR9600)

- To select the tuner and desired band (AM or FM), press the **BAND** button on the front panel
- Turn the **GYRO TUNING** dial on the front panel to select the desired station.

(Using the remote control unit)

- To select the tuner and desired band (AM or FM), tap the **AM** or **FM**.
- Tap the Tuning **▲** or **▼**.

Note:

- Reception sensitivity worsens when simultaneously using tuner 1 and 2 in the below cases. In such case, moving the antennas farther apart improves reception.

FM:

$$\begin{aligned} \text{Tuner 1 frequency} + 10.7 \text{ MHz} &= \\ &= \text{Tuner 2 frequency} \\ \text{Tuner 2 frequency} + 10.7 \text{ MHz} &= \\ &= \text{Tuner 1 frequency} \end{aligned}$$

AM:

$$\begin{aligned} \text{Tuner 1 frequency} + 450 \text{ kHz} &= \text{Tuner 2 frequency} \\ \text{Tuner 2 frequency} + 450 \text{ kHz} &= \text{Tuner 1 frequency} \end{aligned}$$

DIRECT FREQUENCY CALL

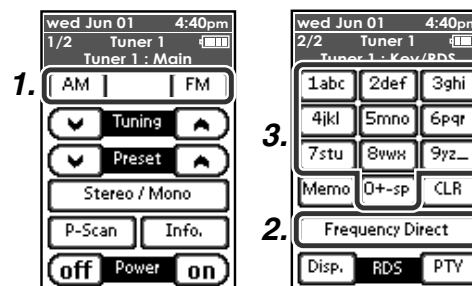

- To select the tuner and desired band (AM or FM), press the **page up** button on the remote control unit until page 2/2 appears.
- Tap the **Frequency Direct**. "FREQ ---" will appear on the display.
- Input your desired station's frequency with the numeric keypad on the remote control unit.
- The desired station will automatically be tuned.

(FM) TUNING MODE (AUTO STEREO OR MONO)

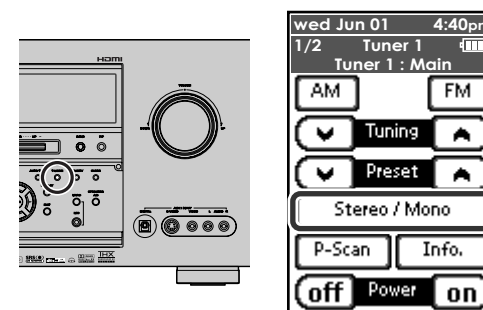

When in the Auto Stereo mode, "AUTO" indicator is illuminated on the display.

The "ST" indicator is illuminated when a stereo broadcast is tuned in.

At open frequencies, the noise is muted and the "TUNED" and "ST" indicators are not illuminated. If the signal is weak, it may be difficult to tune into the station in stereo. In such a case, press the **T-MODE** button on the front panel or tap the **Stereo/Mono** on the remote control unit. "AUTO" indicator is illuminated on the display.

PRESET MEMORY

You can preset up to 50 AM/FM stations in any order. This memory is shared by both tuners 1 and 2.

For each station, you can memorize the frequency and reception mode if desired.

AUTO PRESET MEMORY

This function automatically scans the AM and FM band and enters all stations with proper signal strength into the memory.

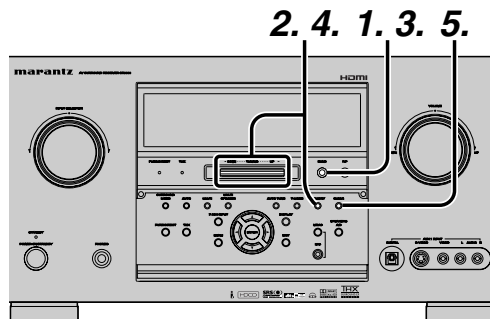

1. To select FM, press the **BAND** button on the front panel.
2. While pressing the **MEMORY** button, rotate the **GYRO TUNING** dial. "AUTO PRESET" will appear on the display, and scanning starts from the lowest frequency.
3. Each time the tuner finds a station, scanning will pause and the station will be played for five seconds. During this time, the following operations are possible. The band can be changed by pressing the **BAND** button.
4. If no button is pressed during this period, the current station is memorized in location Preset 02. If you wish to skip the current station, rotate the **GYRO TUNING** dial during this period. This station is skipped and auto presetting continues.
5. Operation stops automatically when all 50 preset memory positions are filled or when auto scanning has reached the upper limit of all bands. If you desire to stop the auto preset memory at anytime, press the **CLEAR** button.

MANUAL PRESET MEMORY

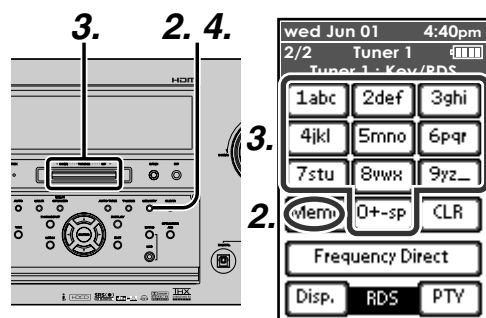

(Using the SR9600)

1. Tune into the desired radio station. (See the "MANUAL TUNING" or "AUTO TUNING").
2. Press the **MEMORY** button on the front panel. "--" (preset number) starts blinking on the display.
3. Select the preset number by rotating the **GYRO TUNING** dial, while it is still blinking (approx. 5 second)
4. Press the **MEMORY** button again to enter. The display stops blinking. The station is now stored in the specified preset memory location.

(Using the remote control unit)

1. Tune into the desired radio station. (See the "MANUAL TUNING" or "AUTO TUNING").
2. Tap the **Memo** on the remote control unit. "--" (preset number) starts blinking on the display.
3. Enter the desired preset number by tapping the numeric keypads.

Note:

- When entering a single digit number (2 for example), either input "02" or just input "2" and wait for a few seconds.

RECALLING A PRESET STATION

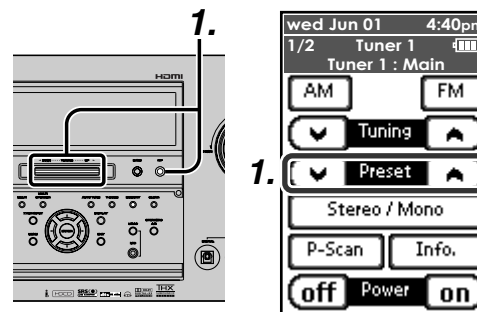

(Using the SR9600)

1. Press the **F/P** button to show the preset station on the display. Select the desired preset station by rotating the **GYRO TUNING** dial on the front panel.

(Using the remote control unit)

1. Tap the **Preset** \wedge or \vee to select the desired preset station, \wedge or input the desired preset channel with the numeric keypad on the remote control unit.

CHECKING THE PRESET STATIONS

The preset broadcast stations can be checked on the onscreen display.

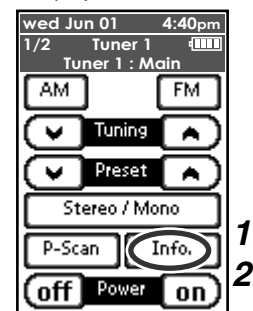

(Using the remote control unit)

1. Tap the **Info.** to view a list of tuner preset stations on the onscreen display.
2. If there are 10 or more preset stations, press the **Info.** button again.

Note:

- The preset station indication disappears in about 5 sec.

PRESET SCAN

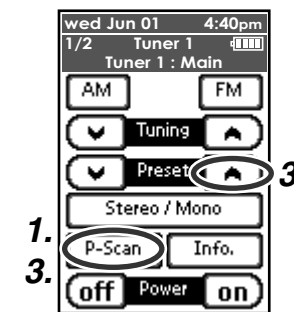

(Using the remote control unit)

1. Tap the **P-Scan** on the remote control unit. "PRESET SCAN" appears on the display and then the preset station with the lowest preset number is recalled first.
2. Preset stations are recalled in sequence (No. 1 → No. 2 → etc.) for 5 seconds each. No stored preset number will be skipped.
3. You can fast forward through the preset stations by tapping the **Preset** \wedge continuously. When the desired preset station is received, cancel the preset scan operation by tapping the **CLEAR** or **P-Scan**.

CLEARING STORED PRESET STATIONS

You can remove preset stations from the memory using the following procedure.

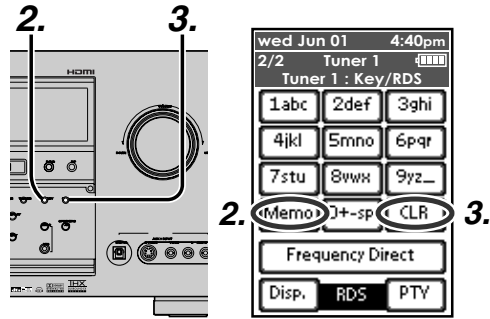

1. Recall the preset number to be cleared with the method described in “**RECALLING A PRESET STATION**”.
2. Press the **MEMORY** button on the front panel or tap the **Memo** on the remote control unit.
3. The stored preset number blinks in the display for 5 seconds. While blinking, press the **CLEAR** button on the front panel or tap the **CLR** on the remote control unit.
4. “xx CLEAR” appears on the display to indicate that the specified preset number has been cleared.

Note:

- To clear all stored preset stations, press and hold the **CLEAR** and the **F/P** buttons for two seconds.

SORTING PRESET STATIONS

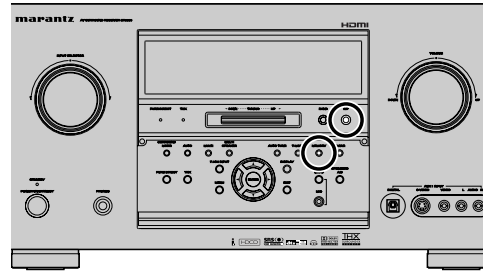

If you have stations memorized, and there is a gap in the sequential order:

e.g., the stations are stored as follows

- 1) 87.1 MHz
- 2) 93.1 MHz
- 3) 94.7 MHz
- 10) 105.9 MHz

(notice there are no stations programmed for presets for 4-9), you can have pre set 10 become preset 4:

To sort the numbers, press and hold the **MEMORY** and the **F/P** buttons. “**PRESET SORT**” will appear on the display and sorting will be done.

NAME INPUT OF THE PRESET STATION

This function allows the name of each preset channel to be entered using alphanumeric characters.

Before inputting names, you need to store preset stations with the preset memory operation.

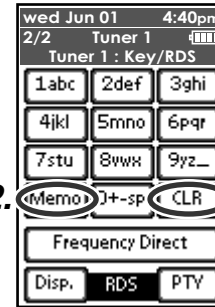
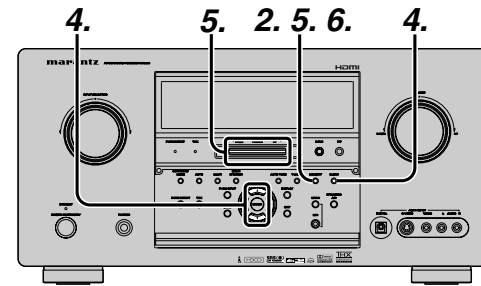

1. Recall the desired preset number with the method described in “**RECALLING A PRESET STATION**”.
2. Press the **MEMORY** button on the front panel or press the **Memo** on the remote for more than 3 seconds.
3. The leftmost column of the station name indicator flashes, indicating the character entry ready status.
4. When press the cursor **▲/▼** buttons on the front panel or the cursor **▲/▼** buttons are pressed on the remote control unit alphabetic and numeric characters will be displayed in the following order:
A → B → C ... Z → 1 → 2 → 3 ... 0 → - → + → /
→ (Blank) → A
UP →
← DOWN

Numeric keypad	Display
1	A → B → C → 1 → A
2	D → E → F → 2 → D
3	G → H → I → 3 → G
4	J → K → L → 4 → J
5	M → N → O → 5 → M
6	P → Q → R → 6 → P
7	S → T → U → 7 → S
8	V → W → X → 8 → V
9	Y → Z → space → 9 → Y
0	- → + → / → 0

To erase the character, press the **CLEAR** button or tap the **CLR** on the remote control unit.

5. After selecting the first character to be entered, press the **MEMORY** button on the front panel or press the **OK / ENTER** button. The entry in this column is fixed and the next column starts to flash. Fill the next column using the same method. To move back and forth between the characters, rotate the **GYRO TUNING** dial or press **◀** or **▶** cursor buttons on the remote control unit.

Note:

Unused columns should be filled by entering blanks.

6. To save the name, press the **MEMORY** button or the **OK** button on the remote control unit for more than 2 seconds.

MULTIROOM SYSTEM

The Multiroom system is a mode which allows you to listen to the same or a different source in two rooms other than the room in which the SR9600 is located.

To use this function, a multiroom remote unit and remote control signal receiver available from your Marantz dealer are necessary.

The operations possible with the multiroom mode are explained briefly below.

For details, refer to the instruction manual supplied with the multiroom remote control unit and receiver.

To output to multirooms A and B, connect the video from the MULTI OUT A/B jacks to the monitors in multirooms A and B as shown in the connection example on page 27. Connect the audio from the MULTI OUT A/B jacks to the amps in multirooms A and B. Or, you can also connect the MULTI SPK (LEFT/RIGHT) terminals to the speakers in multirooms A and B.

The SR9600 supports some Multiroom system features such as source selector, OSD information, sleep timer, Multiroom Speaker output and remote control.

The multiroom feature of the SR9600 allows use in two rooms, A and B, however the Multispeaker mode can be used in only one of the two rooms.

MULTIROOM PLAYBACK USING THE MULTI ROOM OUT TERMINALS

The SR9600's MULTI ROOM A/B output terminals include audio pre-out terminals for which the volume is adjustable and composite video output terminals.

A stereo power amplifier (sold separately) can be connected to enjoy multi room playback.

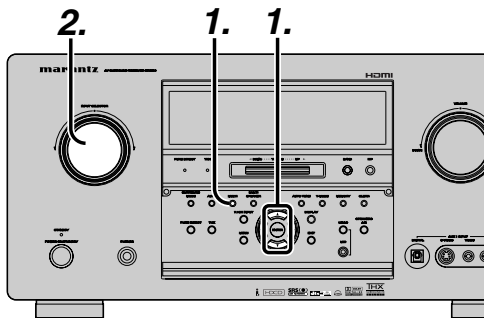

OPERATION TO MULTI ROOM OUT WITHOUT THE REMOTE CONTROLLER.

1. Press the **MULTI** button. A menu appears for setting the source and volume for rooms A and B. Select a room with the **▲** or **▼** cursor buttons. The "MULTI" indicator flashes for approx. 10 seconds.
2. Select the input source using the **INPUT SELECTOR** knob.
3. Set the volume level in the multiroom as desired. This will only set the volume in the MULTI A or B rooms.
4. Press the **SLEEP** button to set the sleep timer for the selected room.

Note:

- Settings can be performed from the MAIN MENU as well. (See page 44)

MULTIROOM OPERATION FROM THE REMOTE CONTROL UNIT

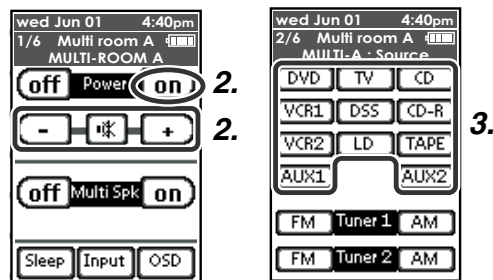

1. Tap either the **Multi room A** or **Multi room B** button on the Home screen.
2. Tap the **Power on** button on page 1/6. The "MULTI A" or "MULTI B" appears on the display. Set the volume with the Volume + and -.
3. Press the **page up** button until page 2/6 appears. Select the input source.

Notes:

- For more information about the Multi room A (or Multi room B) screens (pages 1/6-6/6), see page 13.
- When only Multiroom A is on, "MULTI A" appears on the display. When only Multiroom B is on, "MULTI B" appears on the display. When both Multirooms A and B are on, "MULTI A-B" appears on the the display.

MULTI ROOM PLAYBACK USING THE MULTI SPEAKER TERMINALS

The SR9600 allows you to connect another set of speakers and place them in a different room or separated area for listening to music.

OPERATION TO MULTI ROOM SPEAKER WITHOUT THE REMOTE CONTROL UNIT.

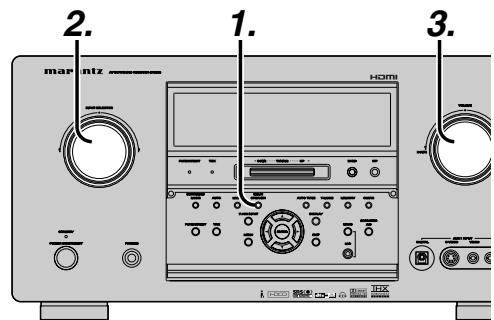

1. Press the **MULTI SPEAKER** button. "SPKR A DVD" is displayed and the "MULTI" indicator flashes for approx. 10 seconds. To set the Multiroom Speaker mode to room B, press the **MULTI SPEAKER** button again.
2. Select the input source using the **INPUT SELECTOR** knob.
3. Set the volume level in the multiroom as desired. This will only set the volume in the multiroom.

Note:

- The Multiroom Speaker mode can also be set from the MAIN MENU. (See page 44)

Notes for Multi Room Speaker

- The Multiroom Speaker mode can be set for only one of the rooms, A or B.
- The MULTI ROOM SPEAKER output terminals can be used when Surround Back Speaker = "NONE" in the SPEAKER SETUP menu. (See SPEAKER SETUP, page 38)
- "The Surr. Back Speakers are in use" is displayed when the **MULTI SPEAKER** button is pressed when the Surround Back Speaker is not set to "NONE" in the SPEAKER SETUP menu. (See SPEAKER SETUP, page 38)
- The Multispeaker mode cannot be used at the same time as the speaker C. When connecting for multiroom use, set the **SPEAKER C** selector switch on the rear panel to OFF.

MULTIROOM SPEAKER OPERATION FROM THE REMOTE CONTROL UNIT

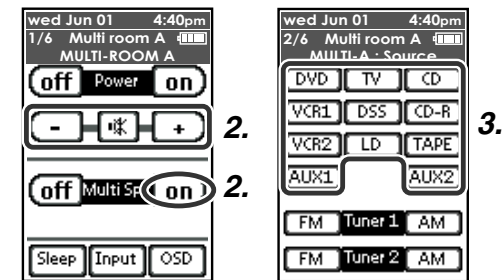

1. Tap either the **Multi room A** or **Multi room B** on the Home screen.
2. Tap the **Multi Spk on** on page 1/6. The MULTI A-SPK (MULTI B-SPK) screen appears on the display. Set the volume with the Volume + and -.
3. Press the **page up** button until page 2/6 appears. Select an input source.

Note:

- When the Multispeaker mode is set to room A, "MULTI A-SPK" appears on the display. When the Multispeaker mode is set to room B, "MULTI B-SPK" appears on the display.

OPERATION OF THE MULTIROOM OUTPUTS WITH THE REMOTE CONTROL FROM MULTI A OR B ROOM

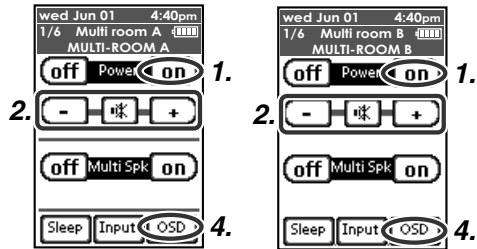

1. Press **MULTI** on the multi room remote control from the multiroom.
Tap the **Multi room A** (or **Multi room B**) on the Home screen on the remote control unit.
Tap the **Power on** on page 1/6.
The multiroom video output will show OSD information for the MULTIROOM A(B) setup.

```

MULTI ROOM A
MULTI ROOM : ON
MULTI SPKR : OFF
SLEEP TIMER : 90 min.
VIDEO : DSS1
AUDIO : TUNER1
          FM 102.00MHz
VOLUME SETUP : VARIABLE
VOLUME LEVEL : -90 dB

- - - MAIN ROOM STATUS - - -
VIDEO : DVD  AUDIO : DVD
  
```

```

MULTI ROOM B
MULTI ROOM : ON
MULTI SPKR : ON
SLEEP TIMER : 90 min.
VIDEO : DSS1
AUDIO : TUNER2
          AM 1000 kHz
VOLUME SETUP : FIXED
VOLUME LEVEL : -90 dB

- - - MAIN ROOM STATUS - - -
VIDEO : DVD  AUDIO : DVD
  
```

2. Tap the **VOL +** or **VOL -** on the multiroom A or B remote control to set the desired volume.
3. In Multiroom mode, the multiroom remote control can be used in the multiroom to operate the following functions.

General:

Controlling volume level, sleep timer and muting.
Selecting input audio and video source.

Tuner 1 or 2:

Selecting the band, changing preset channel up and down, tuning up and down, direct frequency call, T-MODE and preset Scan.

4. To view OSD information, tap the **OSD** on page 1/6.

Notes for the Multiroom System

- The MULTI ROOM OUT (MULTI OUT/MULTI SPEAKER) terminals have analog outputs. Digital input signals are not supported.
- If the Tuner 1 (AM or FM) is active in the main room, you can not control any function of Tuner 1 from multiroom A or B. However, Tuner 2 can be controlled.
In this case, you must listen to the same station as in the main room.
- OSD information cannot be displayed simultaneously in both Multirooms A and B.
- When the component with RC-5 bus is connected to the MULTI RC IN jack (see page 27), Multiroom A can be operated using the RC codes for the main room. The remote control units of other Marantz products can also be used to control multiroom A.

TROUBLESHOOTING

In case of trouble, check the following before calling for service:

1. Are the connections made properly?
2. Are you operating the unit properly following the user's guide?
3. Are the power amplifiers and speaker working properly?

If the unit does not operate properly, check items shown in the following table. If your trouble cannot be recovered with the remedy actions listed in the following table, malfunction of the internal circuitry is suspected; immediately unplug the power cable and contact your dealer, nearest Marantz authorized dealer or the Marantz Service Center in your country.

SYMPTOM	CAUSE	REMEDY
The SR9600 cannot be turned on.	The power plug is not connected.	Connect the power plug to the outlet.
No sound and picture are output even when power is on.	Mute is on.	Cancel mute using the remote control unit.
	The input cable is not connected correctly.	See the connection diagram and connect the cables correctly.
	The master volume control is turned all the way down.	Adjust the master volume.
	The function selector position is wrong.	Select the correct position.
No speaker output.	The headphones are connected to the headphone jack.	Disconnect the headphones. (Speakers will not output sound when headphones are connected.)
Incorrect audio or video for selected source.	The input cable is connected incorrectly.	Connect the cable correctly by referring to the connection diagram.
Incorrect audio from a channel.	The speaker cable is connected incorrectly.	Connect the cable correctly by referring to the connection diagram.
No audio is output from the center channel speaker.	The center speaker cable connection is incomplete.	Connect the cable correctly.
	STEREO has been selected for the Surround mode.	When STEREO is selected for the Surround mode, no sound will be output from the center speaker. Set another Surround mode.
	Center = NONE has been selected in SETUP mode.	Make the correct setting.
No audio is output from the surround speakers.	The surround speaker cable connection is incomplete.	Connect the cable correctly.
	STEREO has been selected for the Surround mode.	When STEREO has been selected for the Surround mode, no sound will be output from the surround speaker. Set another Surround mode.
	Surround = NONE has been selected in the SETUP mode.	Make the correct setting.
No audio is output from the surround back speakers.	The surround back speaker cable connection is incomplete.	Connect the cable correctly.
	The surround mode is not EX/ES mode.	Set surround mode EX/ES.
	Surround back = NONE has been selected in the SPEAKER SIZE menu.	Make the correct setting.

SYMPTOM	CAUSE	REMEDY
Cannot select the EX/ES or THX EX mode.	Surround Back = NONE has been selected in the SPEAKER SIZE menu.	Make the correct setting.
	The input signal is incompatible.	Use a 5.1 channel source.
Cannot select THX ULTRA 2 CINEMA MUSIC, GAMES.	Surround Back = 1ch. NONE has been selected in the SPEAKER SIZE menu	Make the correct setting.
	The input signal is incompatible.	Use a 5.1 channel source.
Cannot select the Neo:6 mode.	The input signal is incompatible.	Use a 2 channel Dolby Digital input signal, PCM input signal or analog input signal.
Ca not select the CSII mode.	The input signal is incompatible.	Use a 2 channel Dolby Digital input signal, PCM input signal or analog input signal.
No output to SUBWOOFER OUT.	Subwoofer = NONE has been selected in the Setup mode.	Select Subwoofer = YES.
Noise is produced during DTS-encoded CD or laserdisc play.	Analog has been selected for input.	Be sure to perform digital connection, select digital input, then play.
A specific channel does not produce output.	Nothing recorded on source.	Check the encoded channel on the source side.
AM or FM reception fails.	Antenna connection is incomplete.	Correctly connect the indoor AM and FM antennas to AM and FM antenna outlets.
Noise is heard during AM reception.	Reception is affected by other electrical fields.	Try changing the location where the AM indoor antenna is set up.
Noise is heard during FM reception.	The radio waves from the broadcasting station are weak.	Install an FM outdoor antenna.
Cannot get programmed station when the PRESET button is pressed.	Preset data has been erased.	Disconnecting power plug for long periods of time will erase preset data. If this happens, input the preset data again.
Control with the remote control unit fails.	Batteries are exhausted.	Replace all the batteries with new ones.
	Remote control unit function key setting is wrong.	Select a different position from which equipment will be controlled.
	The distance between the SR9600 and the remote control unit is too far.	Move closer to the SR9600.
	Something is blocking the SR9600 and the remote control unit.	Remove the offending object.
MRAC is not working.	Headphones are connected.	Disconnect the headphones.

Note:

- After "PROTECT" appears on the unit's display, the standby indicator may start flashing. If it does, there is a problem in the unit or the connection. If this problem reoccurs even when power is activated from the remote control unit, call for servicing.

HDMI

SYMPTOM	CAUSE	REMEDY
The display does not appear over an HDMI connection.	The connected monitor or projector does not support HDCP.	
	The HDMI input of on the TV is not on.	Set HDMI input so that it turns on, as explained in the TV's instruction manual.
	The HDMI output on the source component (DVD, Set Top Box, etc.) is not on.	Set HDMI output so that it turns on, as explained in the source component's instruction manual.
	The HDMI mode is not correctly set on the SR9600.	Set HDMI input on the FUNC INPUT SETUP menu as explained on page 33.
	The HDMI output video resolution of the source component (DVD, Set Top Box, etc.) does not match the TV specifications.	Set the resolution so that it matches, as explained in the instruction manuals of both components.
	The device is connected with a non-standard HDMI cable.	A 5 m or shorter cable is recommended to ensure stable operation and prevent image quality deterioration.
	Power to the SR9600 is off. (When the SR9600 is on standby, HDMI connections cannot be turned on.)	Turn on the power to the SR9600.
The connection between HDMI components was not authenticated.	Shut off and then turn the power back on to the SR9600, TV and source component.	
The SR9600 SETUP menu does not appear over an HDMI connection.	The SR9600 SETUP menu does not support HDMI output.	Use the COMPONENT VIDEO, S-VIDEO or VIDEO output.
Time is needed for the display of an HDMI connection to appear.	The connection is being authenticated between the HDMI devices.	There is nothing wrong with the system. Some HDMI devices require time for authentication.
Audio is not played back over an HDMI connection.	The HDMI audio output of the source component (DVD, Set Top Box, etc.) is not on.	Set the HDMI audio output so that it turns on, as explained in the source component's instruction manual.
	The signal format of the source component (DVD, Set Top Box, etc.) is not supported by the SR9600.	Set the HDMI audio output so that it can connect to the SR9600, as explained in the source component's instruction manual.
	The SR9600 is set to the HDMI audio "THROUGH" mode.	In the "THROUGH" mode, sound is not produced from the SR9600. Set it to "ENABLE". (see page 44)
DVD-Audio is not played back over an HDMI connection.	The DVD player does not support CPPM, therefore it cannot output HDMI audio.	<ul style="list-style-type: none"> • Use a DVD-Audio player that supports CPPM. • Turn on PCM downsampling on the DVD player. • Use an analog connection.

SYMPTOM	CAUSE	REMEDY
Super Audio CD is not played back over an HDMI connection.	The current HDMI connection does not support Super Audio CDs.	Use an analog connection.

i.LINK (AUDIO)

SYMPTOM	CAUSE	REMEDY
Audio is not played back over an i.LINK connection.	The connected component does not support i.LINK (Audio).	Use a component that supports i.LINK (Audio).
	The connected component does not support DTCP (Digital Transmission Content Protection).	Use a device that supports DTCP.
	The i.LINK mode on the SR9600 is not correctly set.	Set i.LINK input on the SETUP menu as explained on page 34.
	The i.LINK output of the source component (DVD, etc.) is not on.	Set i.LINK output so that it turns on, as explained in the source component instruction manual.
	Power to one of the components in a daisy chain or tree connection is not on.	Turn on power to all devices in the i.LINK connection.
	There are too many i.LINK devices outputting signals on the i.LINK bus.	Disconnect unused i.LINK devices.
	Audio is not played back for a few seconds when the input source is changed or the power is shut off and turned back on.	Authentication is being performed for copyright protection.
The analog audio of the connected component is not played back over i.LINK.	Components disable analog output when an i.LINK connection is on.	Change the i.LINK setting on the component.
The digital output of the connected component is not played back over i.LINK.	Components disable digital output when an i.LINK connection is on.	Change the i.LINK setting on the component.

GENERAL MALFUNCTION

If the equipment malfunctions, this may be because an electrostatic discharge or AC line interference has corrupted the information in the equipment memory circuits. Therefore:

- disconnect the plug from the AC line supply
- after waiting at least three minutes, reconnect the plug to the AC line supply
- re-attempt to operate the equipment

Memory backup

- In case a power outage occurs or the power cord is accidentally unplugged, the SR9600 is equipped with a backup function to prevent memory data such as the preset memory from being erased.

HOW TO RESET THE UNIT

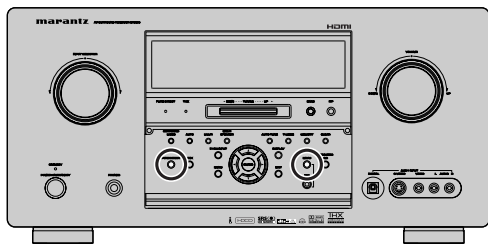

Should the operation or display seem to be abnormal, reset the unit with the following procedure.

With the SR9600 turned on, press and hold the **MRAC** and **PURE DIRECT** buttons simultaneously for 3 seconds or more.

Remember that the procedure will reset the settings of the function selector, Surround mode, delay time (tuner preset) etc., to their initial settings.

TECHNICAL SPECIFICATIONS

FM TUNER SECTION

Frequency Range	87.5 - 108.0 MHz
Usable Sensitivity	IHF 1.8 μ V/16.4 dB
Signal to Noise Ratio	Mono/Stereo 75/70 dB
Distortion	Mono/Stereo 0.2/0.3%
Stereo Separation	1 kHz 45 dB
Alternate Channel Selectivity	\pm 300 kHz 60 dB
Image Rejection	98 MHz 70 dB
Tuner Output Level	1 kHz, \pm 75 kHz Dev 800 mV

AM TUNER SECTION

Frequency Range	520 - 1710 kHz
Signal to Noise Ratio	50 dB
Usable Sensitivity	Loop 400 μ V
Distortion	400Hz, 30 % Mod. 0.5%
Selectivity	\pm 20 kHz 70 dB

AUDIO SECTION

Power Output (20 Hz - 20 kHz/THD=0.08%)	
Front L&R	8 ohms 140 W/Ch
Center	8 ohms 140 W/Ch
Surround L&R	8 ohms 140 W/Ch
Surround Back L&R	8 ohms 140 W/Ch
Front L&R	6 ohms 170 W/Ch
Center	6 ohms 170 W/Ch
Surround L&R	6 ohms 170 W/Ch
Surround Back L&R	6 ohms 170 W/Ch
Input Sensitivity/Impedance	200 mV/ 47 Kohms
Signal to Noise Ratio(Analog Input / Pure Direct)	105 dB
Frequency Response	
(Analog Input / Pure Direct)	
.....	8 Hz - 100 kHz (\pm 3 dB)
(Digital Input / 96 kHz PCM)	
.....	8 Hz - 45 kHz (\pm 3 dB)

VIDEO

Television Format	NTSC
Input Level/Impedance	1 Vp-p/75 ohms
Output Level/Impedance	1 Vp-p/75 ohms
Video Frequency Response	5 Hz to 8 MHz (-1 dB)
Video Frequency (Component) ...	5 Hz to 80 MHz (-1 dB)
S/N	60 dB

HDMI

Version	1.1
---------------	-----

GENERAL

Power Requirement	AC 120 V 60 Hz
Power Consumption	6.5 A
Weight	57.3 lbs (26.0 Kg)

ACCESSORIES

Remote Control Unit RC3200B	1
Microphone MC-10	1
AA-size Batteries	3
FM Antenna	2
FM Antenna Adaptor	2
AM Loop Antenna	2
Front AUX Jack Cover	1
AC cable	1
RS232C Cable	1

Specifications subject to change without prior notice.

DIMENSIONS

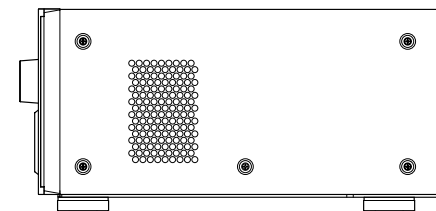
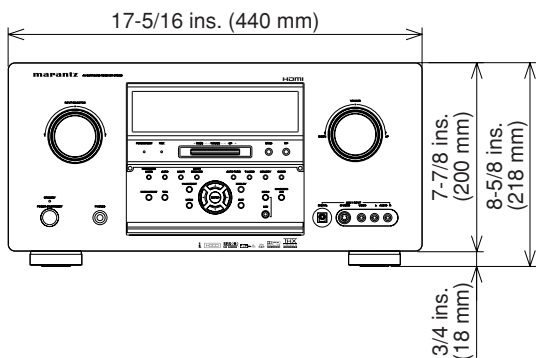
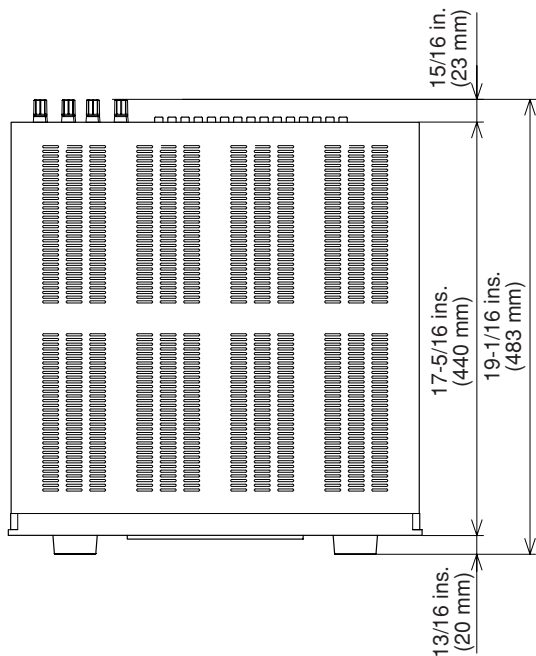

www.marantz.com

You can find your nearest authorized distributor or dealer on our website.

U.S.A. Marantz America, Inc. 1100 Maplewood Drive, Itasca, IL 60143, U.S.A.

EUROPE Marantz Europe B.V. P.O. Box 8744, 5605 LS Eindhoven, The Netherlands

Manufactured under license from Dolby Laboratories. "Dolby", "Pro Logic", "Surround EX" and the double-D symbol are trademarks of Dolby Laboratories. Confidential Unpublished Works. © 1992-1997 Dolby Laboratories, Inc. All rights reserved.

marantz[®] is a registered trademark.

